



# SEA<sup>®</sup>

CE | UK  
CA

ENGLISH

Automatic Gate Openers

International registered trademark n. 804888

# GATE 1 DG

GATE 1 DG R2BF

GATE 1 DG R2EF

GATE 1 DG R3BF

ELECTRONIC CONTROL UNIT

TO MANAGE

A 230V or 110V OPERATOR

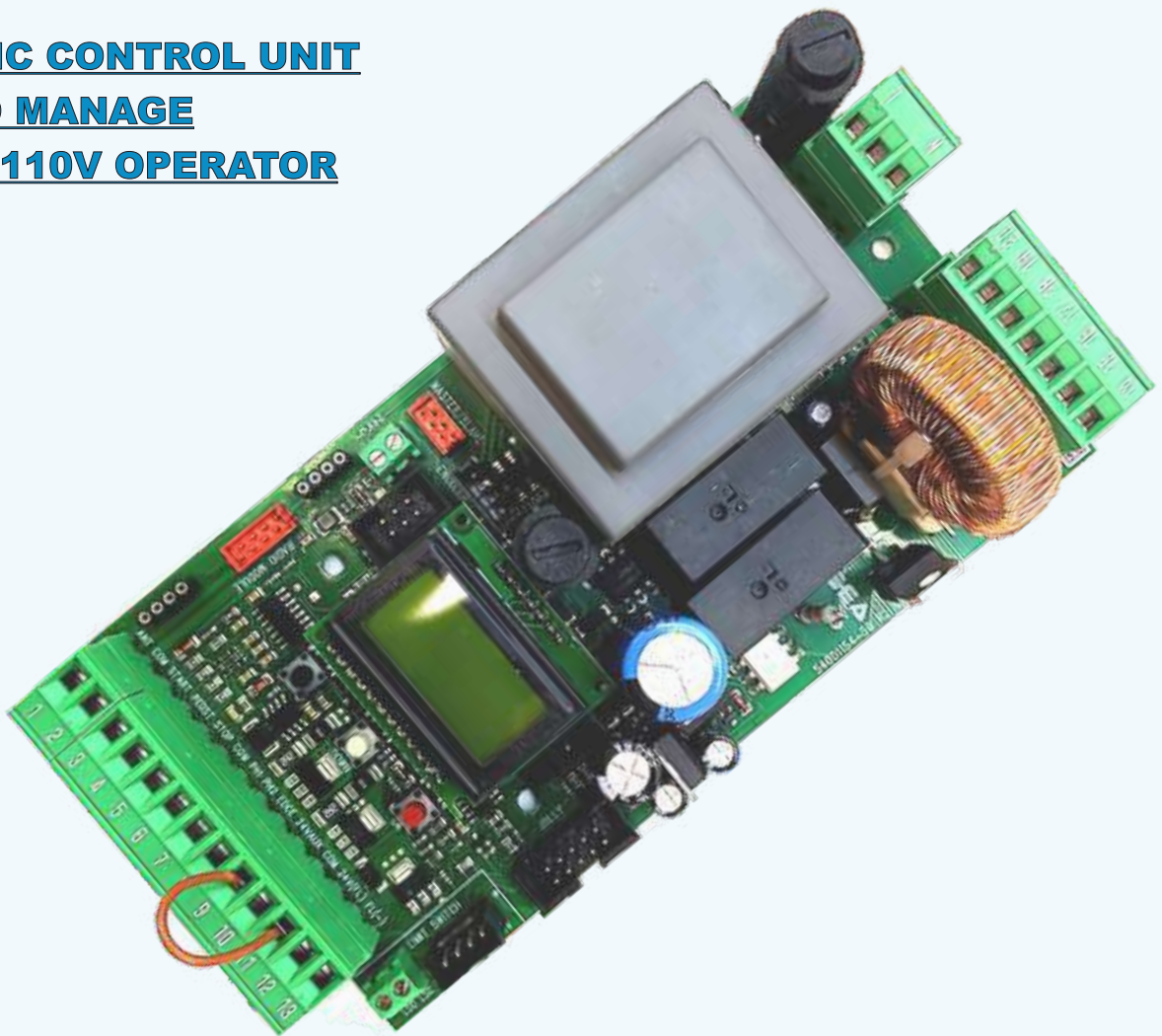

**SEA S.p.A.**

Zona Industriale Sant'Atto - 64100 - Teramo - ITALY

Telephone: + 39 0 861 588341

[www.seateam.com](http://www.seateam.com)

# INDEX

<b>PRELIMINARY INFORMATION AND PRODUCT DETAILS</b> .....	<b>4</b>
<b>1 - WIRINGS</b> .....	<b>5</b>
<b>2 - CONNECTIONS ON CN1</b>	
START, PARTIAL START AND STOP BUTTONS, PHOTOCELLS, TIMER .....	<b>6</b>
FLASHING LIGHT, SAFETY EDGE, SAFETY LOOP .....	<b>7</b>
10K PHOTOCELLS AND BUZZER, EXTERNAL RECEIVER .....	<b>8</b>
«LATCH» BUTTONS, «FIRE SWITCH» FUNCTION, «STAR 400/800» EMERGENCY BATTERIES .....	<b>9</b>
24VAUX INPUT OPTIONS - LOCKS CONNECTION (MAGNETIC, 12V ELECTRIC LOCK, VERTICAL) .....	<b>10</b>
<b>3 - CONNECTIONS ON CN2</b>	
MOTOR WIRINGS, THREE-PHASE MOTOR WIRINGS, COURTESY LIGHT .....	<b>11</b>
<b>4 - CONNECTIONS ON CN3</b>	
CONTROL UNIT POWER SUPPLY .....	<b>12</b>
<b>5 - CONNECTIONS ON CN4</b>	
24VAC INPUT, SYNCHRONIZED PHOTOCELLS CONNECTION .....	<b>12</b>
<b>6 - CONNECTIONS ON CN5</b>	
STANDARD ENCODER CONNECTION AND MANAGEMENT .....	<b>13</b>
<b>7 - CONNECTIONS ON CN6 and CN7</b>	
LIMIT SWITCH CONNECTION (PRE-WIRED AND NON PRE-WIRED) .....	<b>13</b>
<b>8 - CONNECTIONS ON CMS - PRIMARY/SECONDARY OPERATION (MASTER / SLAVE)</b>	
CIRCUIT CONNECTION AND MANAGEMENT OF THE PRIMARY/SECONDARY OPERATION .....	<b>14</b>
<b>9 - CONNECTIONS ON EXP - EXTERNAL MODULES</b>	
«SEM2» CIRCUIT, «LSE» «LE» «LRT» CIRCUITS, TEMPERATURE PROBE WIRING AND MANAGEMENT .....	<b>15</b>
«POSITION GATE» POTENTIOMETER WIRINGS, ENCODER «RT» WIRINGS .....	<b>16</b>
«POSITION GATE» AND ENCODER «RT» MANAGEMENT AND SETTINGS .....	<b>17</b>
<b>10 - RECEIVERS CONNECTION ON CNA and CNS</b>	
PLUG-IN RECEIVERS CONNECTION .....	<b>18</b>
<b>11 - ADDITIONAL FUNCTIONS OF THE CONTROL UNIT</b>	
MANAGEMENT OF THE AMPEROMETRIC FUNCTION, «SURGE PROTECTOR» CIRCUIT CONNECTION .....	<b>19</b>

# INDEX

<b>12 - DISPLAY OPERATION AND PROGRAMMING MENU</b>	
UNIT SWITCHING ON, DISPLAY READING, BASIC MENU AND SPECIAL MENU .....	<b>20</b>
<b>13 - BASIC MENU</b>	
BASIC MENU DIAGRAM AND OPERATION .....	<b>21</b>
<b>14 - INPUTS STATUS MANAGEMENT</b>	
READING OF THE <i>N.C.</i> OR <i>N.O.</i> STATUS OF THE INPUTS ON THE DISPLAY .....	<b>22</b>
DIAGRAM AND OPERATION OF THE INPUTS MANAGEMENT MENU .....	<b>23</b>
<b>15 - WORKING TIMES LEARNING - PROGRAMMING OF THE CONTROL UNIT</b>	
PRELIMINARY SETTINGS, ENCODER OR POTENTIOMETER ACTIVATION .....	<b>24</b>
QUICK TIMES LEARNING FOR SLIDING OPERATORS, TIMES LEARNING THROUGH LIMIT SWITCH .....	<b>25</b>
TIMES LEARNING THROUGH STANDARD ENCODER, THROUGH POTENTIOMETER «POSITION GATE» .....	<b>26</b>
TIMES LEARNING THROUGH MANUAL PULSES ( <i>WITH OR WITHOUT POTENTIOMETER</i> ) .....	<b>27</b>
MANUAL TIMES LEARNING FOR SLIDING OPERATORS WITH «RT» ENCODER .....	<b>28</b>
<b>16 - OPERATING LOGICS</b>	
SEMI-AUTOMATIC, AUTOMATIC, SAFETY, STEP-BY-STEP 1 AND 2, DEAD MAN, 2 BUTTONS .....	<b>29</b>
<b>17 - PASSWORD - PROTECTION OF THE CONTROL UNIT BY PASSWORD</b>	
PASSWORD ENTRY PROCEDURE .....	<b>29</b>
<b>18 - RECEIVERS AND TRANSMITTERS - PROGRAMMING OF THE TX</b>	
«ROLLING CODE», «ROLLING CODE PLUS», «UNI», «FIX CODE» TRANSMITTERS .....	<b>30</b>
DIAGRAM OF THE AVAILABLE FUNCTIONS FOR TRANSMITTERS .....	<b>31</b>
<b>19 - ALARMS and FAULTS WARNINGS - VIA DISPLAY OR FLASHING LIGHT</b>	
LIST OF FAULTS SHOWN ON THE DISPLAY .....	<b>32</b>
LIST OF FAULTS INDICATED BY FLASHING LIGHT, DIAGNOSTICS MENU .....	<b>33</b>
<b>20 - TROUBLESHOOTING</b>	
MOST FREQUENT PROBLEMS AND SOLUTIONS .....	<b>34</b>
<b>MENU TABLE</b> .....	<b>36</b>

## PRELIMINARY

● **The GATE 1 DG requires the programming of the working times (chapter 15);** it is not possible to start the operator correctly without first programming the control unit!

● The unit and the accessories programming and settings can be carried out by the display on board or by the **JOLLY 3** programmer or **SEACLOUD**



JOLLY 3



SEACLOUD



● Functions and menus here described are valid only for the below listed software revisions; if some functions or menus do not correspond to your control unit, consult the previous manuals

<u>MODEL</u>	<u>SOFTWARE REVISION</u>	<u>MAIN DIFFERENCES BETWEEN THE 3 VERSIONS</u>
GATE 1 DG R2BF	03.08	→ With amperometric management; optional «RF» or «FIX» receiver
GATE 1 DG R2EF	03.08	→ No Amperometric management; «FIX» receiver standard on board
GATE 1 DG R3BF	00.05	→ No Amperometric management; optional «RF» or «FIX» receiver, possibility of «FIX» receiver memory expansion, possibility of connecting one or two 8K2 resistive safety edges



**All the wirings (circuits and accessories) must be made when the control unit is OFF and not powered;** only after completing all wirings the control unit can be switched on and programmed

## TECHNICAL INFORMATION



POWER SUPPLY	ABSORPTION IN STAND-BY	OPERATING TEMPERATURE	PROTECTION CLASS OF THE PLASTIC BOX (IF INCLUDED)
230VAC - 50/60 Hz OR 115VAC - 50/60 Hz	30 mA	-20° C  +50° C 	IP 55

## QUICK START

- Make all connections (**control unit OFF!**): motors, accessories and power cables
- **DO NOT jumper the N.C. contacts! - automatic detection of the N.C. contacts not in use!**
- Power on the control unit and check the correct status of the inputs (**chapter 14**)

● Enter the basic menu and set the following menus:  
(if you do not set a time on menu 7, the logic will be «**semi-automatic**» - automatic reclosing disabled)



● Move the operator using the menu **192 MOVE GATE** ; if the gate opens by pressing  and if the gate closes by pressing , then the motor runs correctly, otherwise swap the motor cables

● If installed, enable the encoder or the potentiometer on menu 32 - **paragraph 15.2**

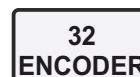

● Start the working times learning by following the procedure in **chapter 15**

# 1 - CONNECTIONS

**!** *Make all the wirings when the control unit is not powered!*  
*Keep the power cables separate from the command cables - always run cables in separate sheaths to prevent interferences!*

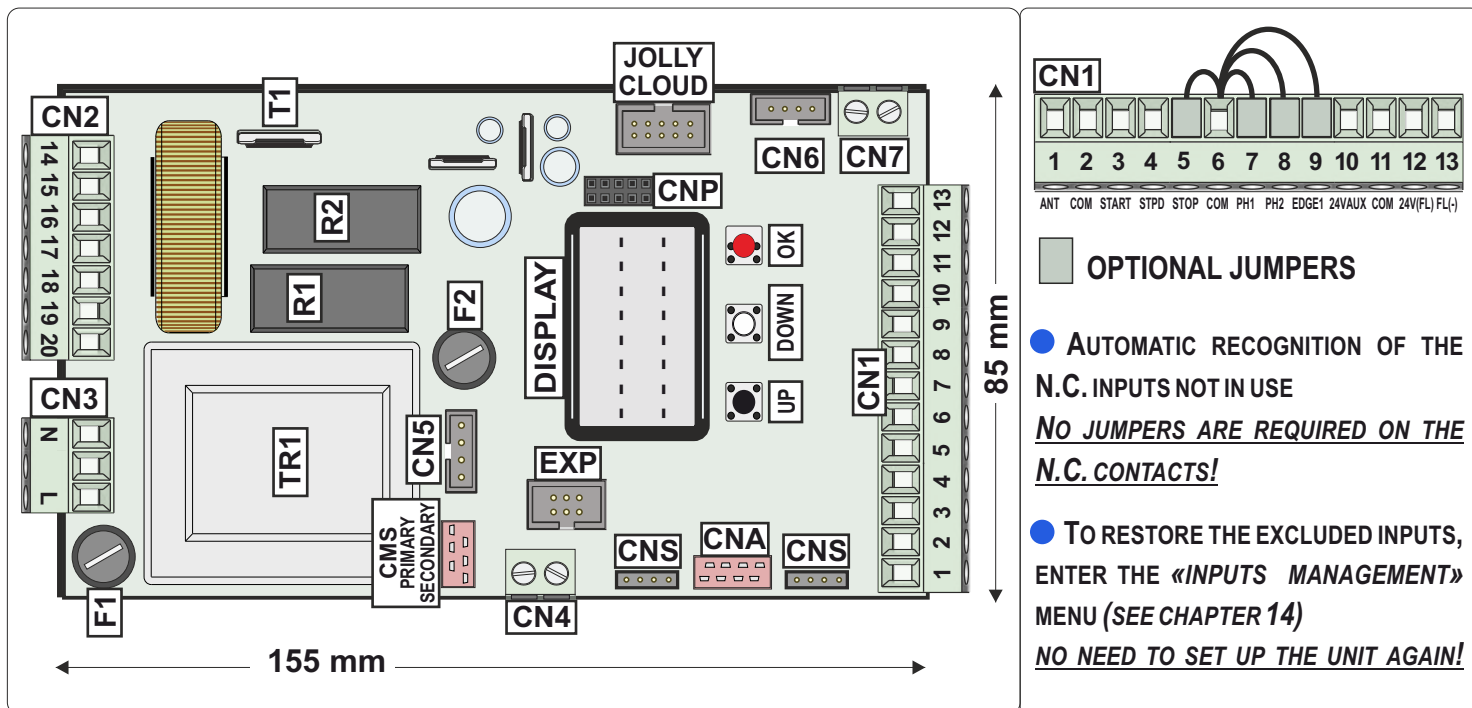

**CN1**

1	2	3	4	5	6	7	8	9	10	11	12	13
ANT	COM	START	STPD	STOP	COM	PH1	PH2	EDGE1	24VAUX	COM	24V(FL)	FL(-)

OPTIONAL JUMPERS

- AUTOMATIC RECOGNITION OF THE N.C. INPUTS NOT IN USE  
NO JUMPERS ARE REQUIRED ON THE N.C. CONTACTS!
- TO RESTORE THE EXCLUDED INPUTS, ENTER THE «INPUTS MANAGEMENT» MENU (SEE CHAPTER 14)  
NO NEED TO SET UP THE UNIT AGAIN!

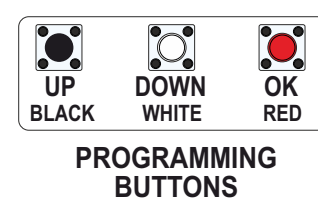
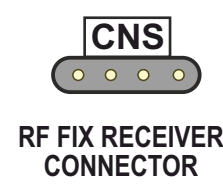
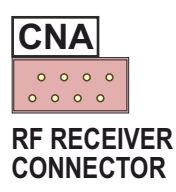
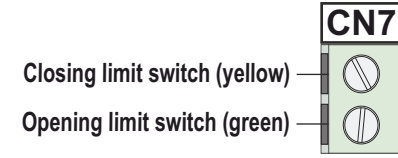
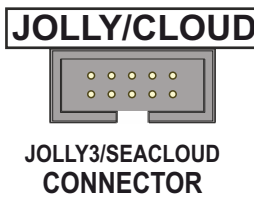
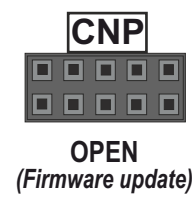
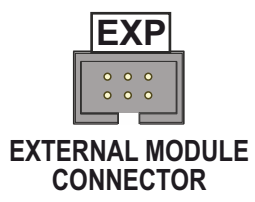
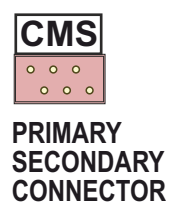
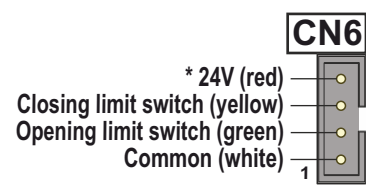
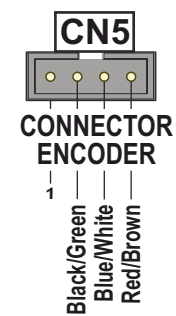
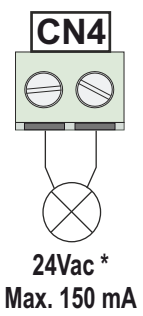
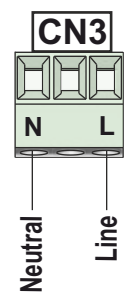
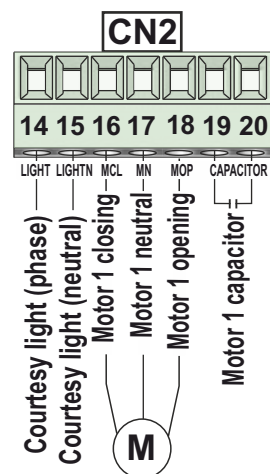
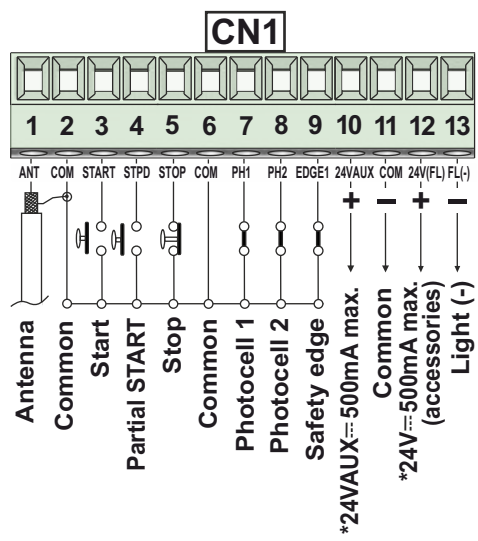

- T1** = MOTOR CONTROL TRIAC
- R1** = MOTOR AND COURTESY LIGHT RELAY
- R2** = MOTOR EXCHANGE RELAY
- F1** = FUSE 6.3AT (230V) OR 10AT (115V)
- F2** = FUSE ACCESSORIES 1A
- TR1** = POWER TRANSFORMER

\* All the 24V inputs support a maximum load of 500mA, referred to the sum of the loads of all 24V accessories connected, including the absorption of the receiver on board (30 mA)

## 2 - CONNECTIONS ON CN1

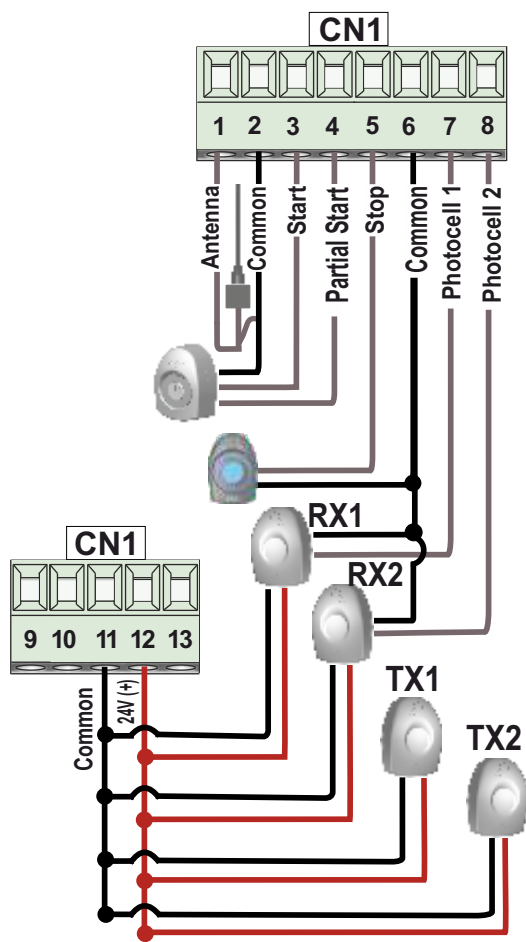

### 2.1 - START (N.O.)

- Connect the «**START**» command on clamps 2 and 3
- Logics to be linked to the «**START**» command in **chapter 16**

⇒ If the input is engaged during the pause time, the gate does not close until the input is released

### 2.2 - PARTIAL START (N.O.)

- Connect the «**PARTIAL START**» command on clamps 2 and 4
- Logics to be linked to the «**START**» command in **chapter 16**

- Partial opening space management: **90 PARTIAL OPENING**
- Partial opening pause time management: **91 PARTIAL PAUSE**

⇒ If the input is engaged during the pause time, the gate does not close until the input is released

**i** If a **traffic light** is wired via SEM unit, it is possible to enable the opening or closing priority linked to the «**START**» or «**PARTIAL START**» commands, via menu **89**

**89**  
TRAFFIC LIGHT  
RESERVATION

### 2.3 - STOP (N.C.)

- Connect the «**STOP**» command on the clamps 5 and 6
- After stopping, press «**START**» to restore the movement

⇒ The operator starts-up in closing after a «**STOP**» command!

### 2.4 - PHOTOCELL 1 AND PHOTOCELL 2 (N.C.)

- Connections: **+ = 24V $\overline{\text{=}}$  MAX 500mA (CLAMP 12)**      **COM = 0V (CLAMPS 2 - 6 - 11)**  
**PH1 = PHOTOCELL 1 (CLAMP 7)**      **PH2 = PHOTOCELL 2 (CLAMP 8)**

- Management

**97**  
PHOTOCELL  
1

**98**  
PHOTOCELL  
2

- «**PHOTOTEST**» function: connect the Tx-photocell positive cable on the clamp 10 and enable the «**PHOTOTEST**» function on menu 94; It is also possible to choose which photocell to test among the options of the menu 95

**94**  
24V AUX

**95**  
PHOTOTEST

⇒ Default settings: **menu 97** = «closing»; **menu 98** = «opening and closing»

⇒ THE USE OF **SHIELDED PHOTOCELLS IS MANDATORY !**

**i** By wiring the photocells power cable to the clamp 10 (AUX) and by setting the menu 94 to «IN CYCLE AND PHOTOTEST», the photocells are tested at every start-up and the energy is saved in stand-by!

### 2.5 - TIMER (N.O.) - EXTERNAL CLOCK

- Connect the timer to the clamp 4 «**PARTIAL START**» or to the clamp 8 «**PHOTOCELL 2**» **92 TIMER**
- If wired to the «**PARTIAL START**», this command will be disabled (*on transmitters too*)
- The timer opens and keeps the gate open until engaged; when released, the gate closes only after the pre-set pause time has elapsed
- In the event of a safety accessory intervention, the timer automatically resets after 6 sec.

⇒ In the event of a power failure when the gate is open:

if the **TIMER** is still active when the power is restored, the gate remains open;  
if the **TIMER** is no longer active, a «**START**» input will be required to close the gate

## 2.6 - 24V $\square$ FLASHING LIGHT - MAX 3W

- Connect the flashing lamp on clamps 12 and 13
- Gate movement signals:
  - 1 BLINK/SECOND IN OPENING
  - 2 BLINKS/SECOND IN CLOSING
  - STEADY LIT DURING PAUSE
- Management: menu 86
- Pre-flashing: menu 85

**86**  
FLASHING  
LIGHT

**85**  
PRE-  
FLASHING

⇒ The control unit sends the warning signals also through the flashing lamp; see **chapter 19**

### EXAMPLE OF FLASHING LAMP AND SAFETY EDGE CONNECTION

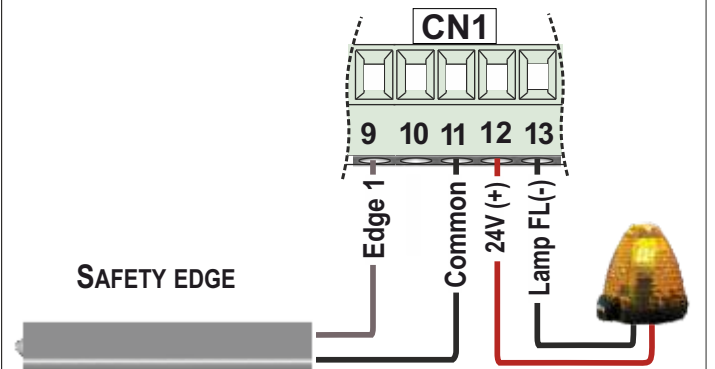

## 2.7 - SAFETY EDGE (N.C.)

- Connect the safety edge 1 on clamps 9 and 11
- Choice of the safety edges type - MENU 100 (MENU 101\*\*)
- Choice of the desired direction - MENU 102 (MENU 103\*)

⇒ Balanced or 8K2 resistive safety edge (single or double): the edge contact is checked through a resistance value to detect short-circuits (an alarm will be displayed!)

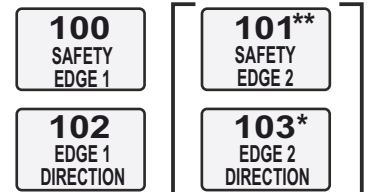

**i** A second safety edge can be connected to the «PHOTOCELL 2» input and can be enabled by setting the menu 98 to «SAFETY EDGE 2»

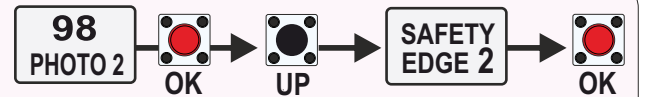

\* The direction of this second safety edge can be managed from menu 103

\*\* Only on the model «GATE 1 DG R3BF»: choice of the safety edge type from menu 101

## 2.8 - SAFETY LOOP

- **FREE EXIT LOOP (LOOP 1)**
  - 3 = START (N.O.)
  - 6 = COMMON
- **REVERSE LOOP (LOOP 2)**
  - 7 = PHOTOCELL 1 (N.C.)
  - 6 = COMMON
- **SHADOW LOOP (LOOP 3)**
  - 8 = PHOTOCELL 2 (N.C.)
  - 6 = COMMON

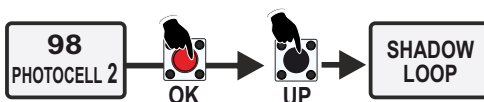

⇒ **USE THE SAFETY LOOP COMBINED WITH THE «ULTRA LOOP PLUG» (23105142)**

### EXAMPLE OF SAFETY LOOP CONNECTION

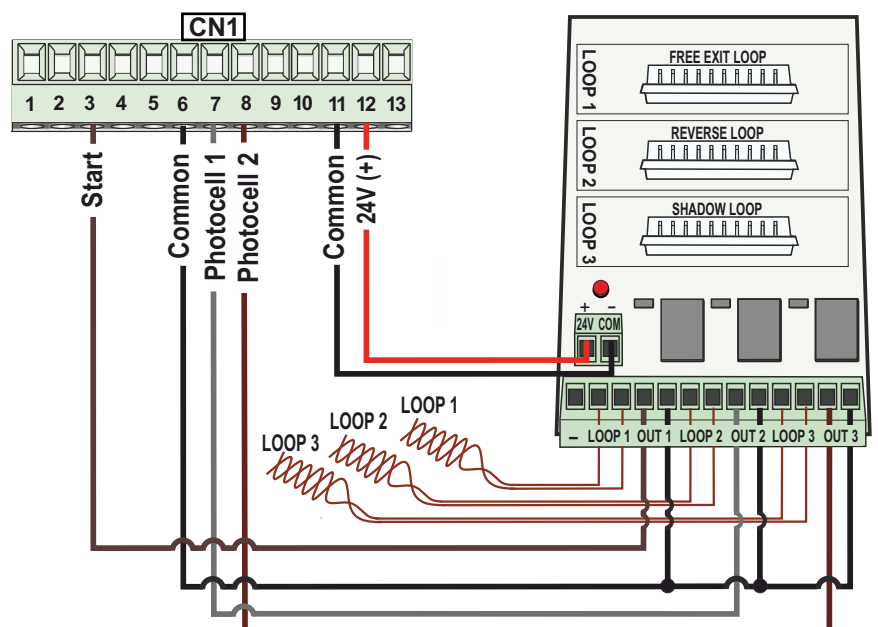

## 2.9 - 10K PHOTOCELL SINGLE OR DOUBLE

### 10K PHOTOCELLS ON «GATE 1 DG R2BF» and «GATE 1 DG R2EF»

- Connect the 10K photocells on clamps 9 - 11 - 12
- One or two 10K photocells can be connected; set the menu 100 on «SINGLE» or «DOUBLE»

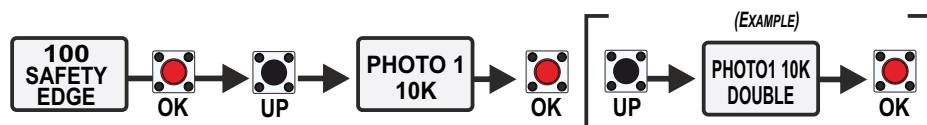

### 10K PHOTOCELLS ON «GATE 1 DG R3BF»

- Connect photocells on clamps 7 - 11 - 12 and 8 - 11 - 12
- Up to four 10K photocells can be connected; set the menus 121 or 122 on «SINGLE» or «DOUBLE»

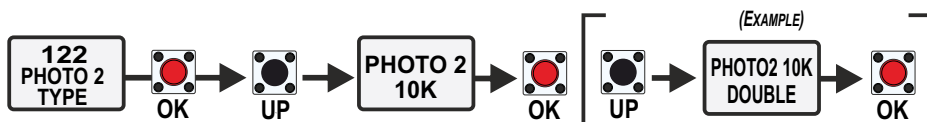
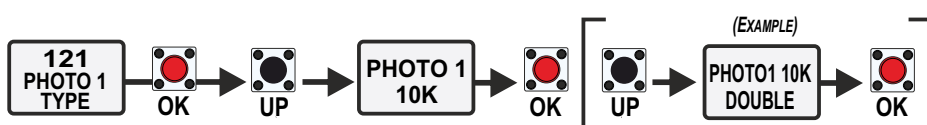

- On all control unit models, it is possible to set the desired operation mode via the «PHOTOCELL» menus

**97**  
PHOTOCELL  
1

**98**  
PHOTOCELL  
2

⇒ By the use of the 10K photocells, a further protection is given, even in the event of a short-circuit on the cables

### EXAMPLES OF 10K PHOTOCELLS CONNECTION

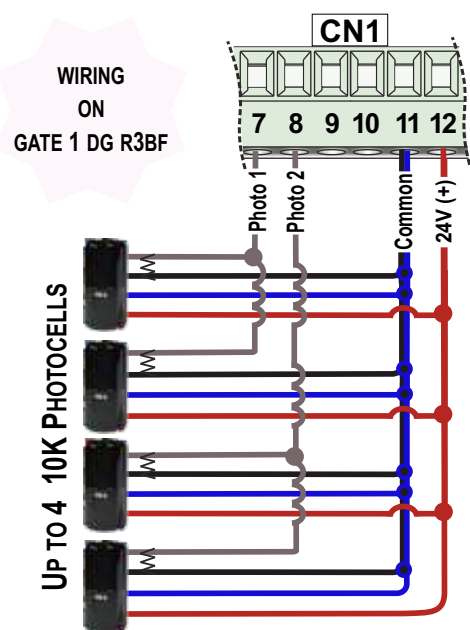
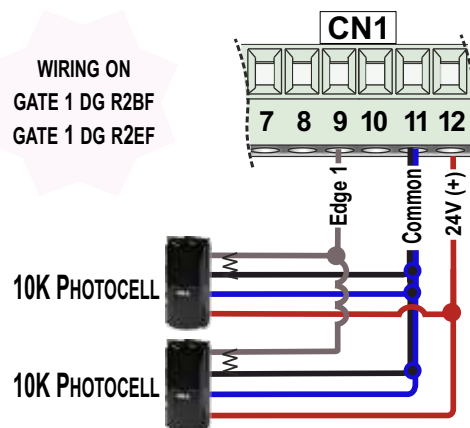

## 2.10 - BUZZER 24V ~

- Connect the buzzer on clamps 12 and 13
- Use a 24V ~ and 100 dB oscillating Buzzer
- The Buzzer can be connected instead of the flashing light; **however, it is necessary to set the menu as «BUZZER»**

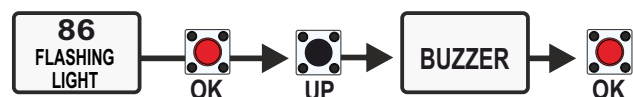

- The Buzzer activates after 2 consecutive interventions of the anti-crushing protection

⇒ Press the STOP button to turn off the buzzer; anyway, the sound switches off automatically after 5 minutes and the operator remains stopped waiting for a new command

### EXAMPLE OF 10K PHOTOCELL AND BUZZER CONNECTION

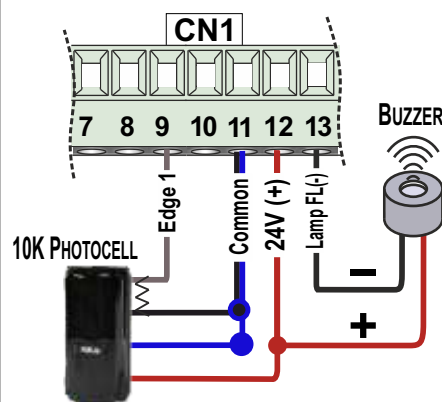

## 2.11 - EXTERNAL RECEIVER

- An external receiver can be connected according to the connection diagram on the side.
- For the operation of the receiver, refer to its instruction manual

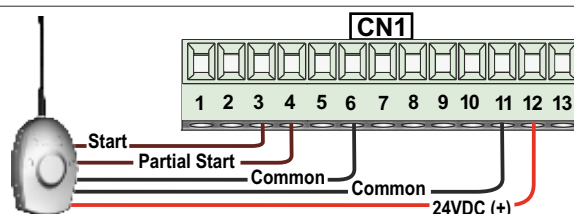



## 2.12 - LATCH OPENING OR LATCH CLOSING BUTTON

- Connect the button to be used as LATCH on clamps 4 and 6

**⚠ THE «PARTIAL START» FUNCTION WILL BE DISABLED**

- Management: set the desired operation mode on menu 118
  - To enable the LATCH, press the LATCH BUTTON; to disable the LATCH, press again the LATCH BUTTON
- ➡ *The Latch function can be also enabled on the second channel of the transmitter (paragraph 18.4)*

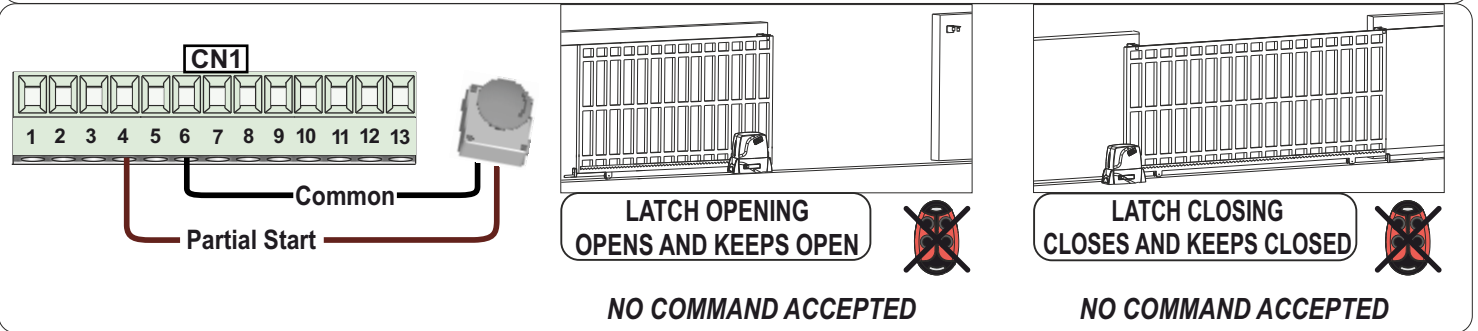
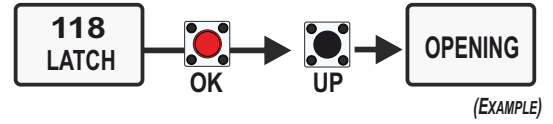

## 2.13 - «FIRE SWITCH» FUNCTION

- The emergency FIRE-SWITCH can be connected on the «PARTIAL START» input (4) or on the «PHOTOCCELL 2» input (8)
- The fire-switch operates in «DEAD MAN» mode and it disables all the safety devices when in use; The button only allows the complete opening (*even when connected to the «PARTIAL START»*)
- To close, first give a «STOP» command followed by a «START» command
- The «FIRE SWITCH» function can be enabled by menu 93

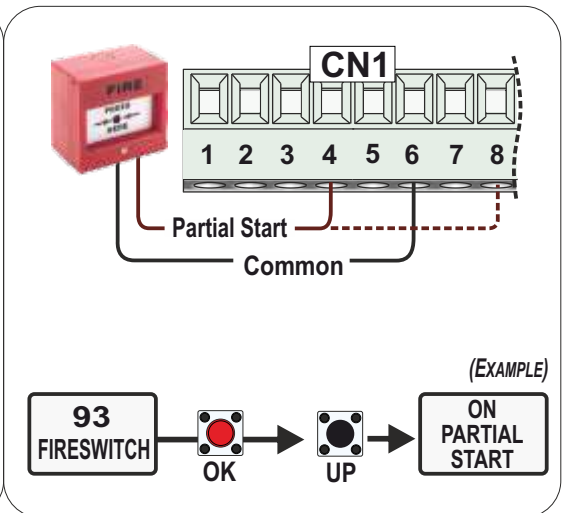

## 2.14 - EMERGENCY BATTERY CONNECTION VIA «LB» CIRCUIT

- The «STAR 400/800» emergency battery pack can be connected through the management unit «LB»
- The «LB» management unit controls the charge of the batteries and allows one last operation before the batteries are completely discharged
- The last operation can be in opening or in closing; on menu 113 you can set the desired option

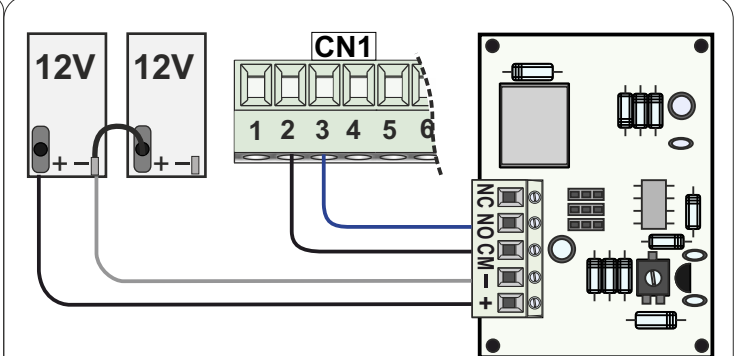
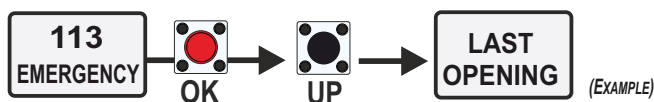

**i** MORE DETAILS ON «STAR 400/800» AND «LB» MANUALS

**⚠ In case of power failure, the last emergency operation is performed as soon as the battery charge drops below 22V**

## 2.15 - 24V $\rightleftharpoons$ DC AUX INPUT OPTIONS - CLAMP 10 - MAX 500mA

- Management: on menu 94 choose how to have voltage on the AUX input, according to the type of accessory you have wired

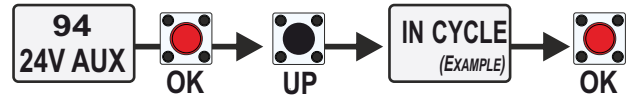

**⚠ CONNECT THE ACCESSORY ONLY AFTER SETTING THE MENU 94 ON THE DESIRED OPTION!**

- A relay can be connected to the 24VAUX input; the relay allows the connection and the management of additional accessories (*courtesy light, locks etc.*); some examples below, including the menu 94 settings

### MAGNETIC LOCK OR 12V ELECTRIC LOCK CONNECTION - BY THE USE OF TWO DIFFERENT RELAY MODELS

- To use the magnetic lock or the 12V electric lock (*max 3A or 15W*), set the menu 94 on «LOCK»

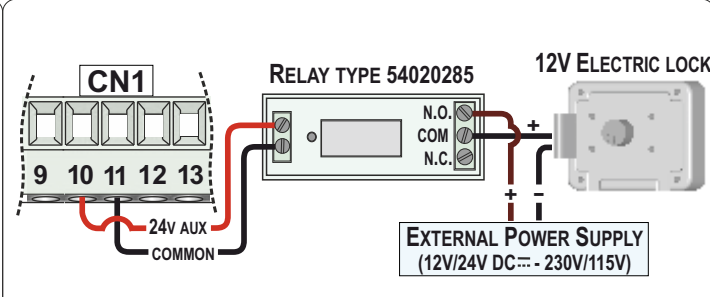
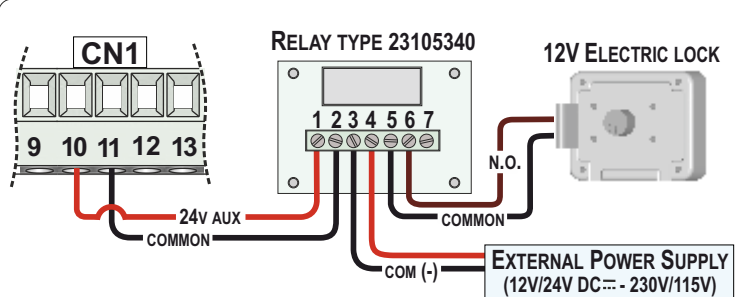
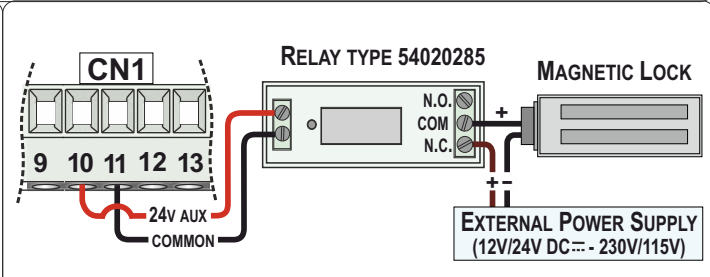
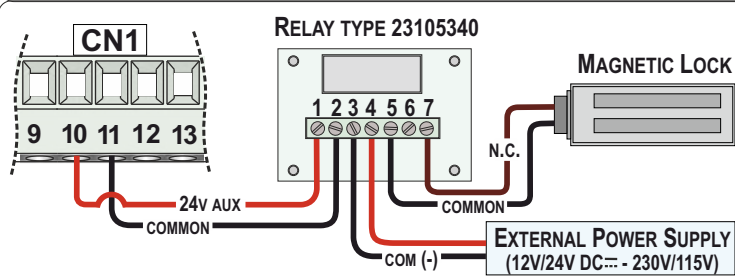
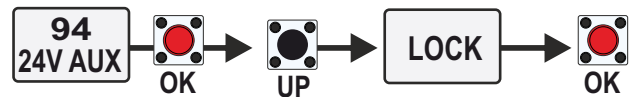

- The «PUSHING STROKE» option simplifies the lock release by giving a little pushing stroke before starting the movement

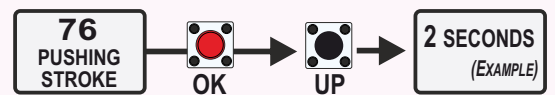

### VERTICAL LOCK CONNECTION - BY THE USE OF TWO DIFFERENT RELAY MODELS

- To use the vertical lock set the menu 94 on «NEGATIVE BRAKE MANAGEMENT» (24Vaux input powered during the cycle and 1 second before starting)

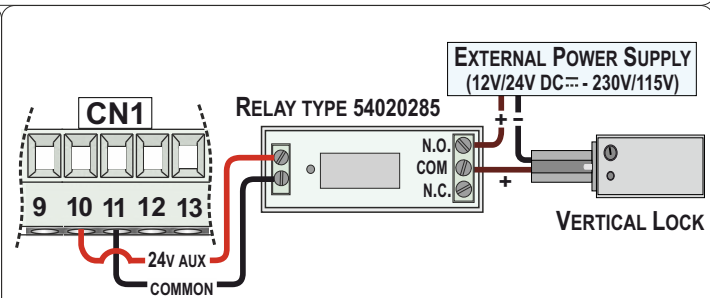
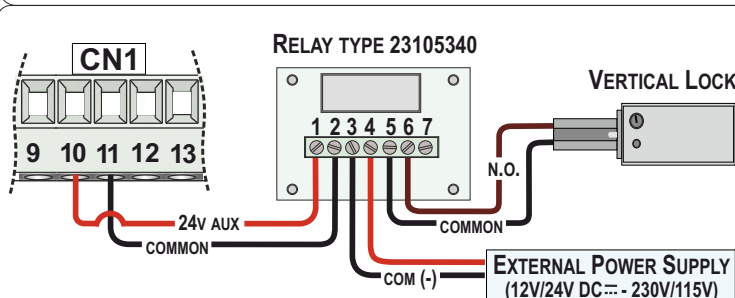
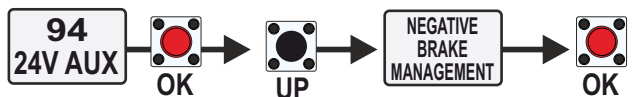

### 3 - CONNECTION ON CN2

#### 3.1 - MOTOR CONNECTION ON THE CONTROL UNIT

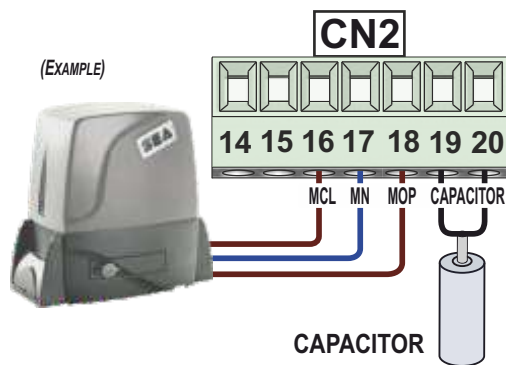

- (M)** MOTOR 1 (230V)
- 16 = MCL - M1 CLOSING
  - 17 = MN - M1 NEUTRAL (BLUE) \*
  - 18 = MOP - M1 OPENING
  - 19 - 20 = CAPACITOR

\* WHITE → 115V

➔ OPERATOR FOR SLIDING GATE ONLY AS EXAMPLE

- According to the model of operator in use, set the menu 3 to the correct type

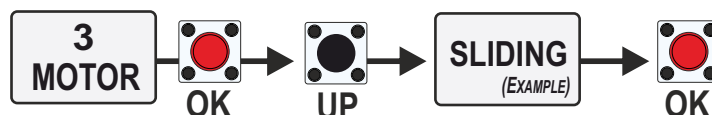

#### 3.2 - THREE-PHASE MODULE CONNECTION

##### THREE-PHASE MODULE MAIN PARTS

- CN1 = 220V POWER SUPPLY
- CN2 = 380V MOTOR
- SFT1 = EARTH GROUNDING FASTON
- K1 = 230V~16A CONTACTOR
- K2 = 230V~16A CONTACTOR
- T1 = THERMAL SWITCH \*

- \* T1 INTERVENTION THRESHOLD
- 3,7A → BIG THREE-PHASE
- 1,8A → LEPUS THREE-PHASE

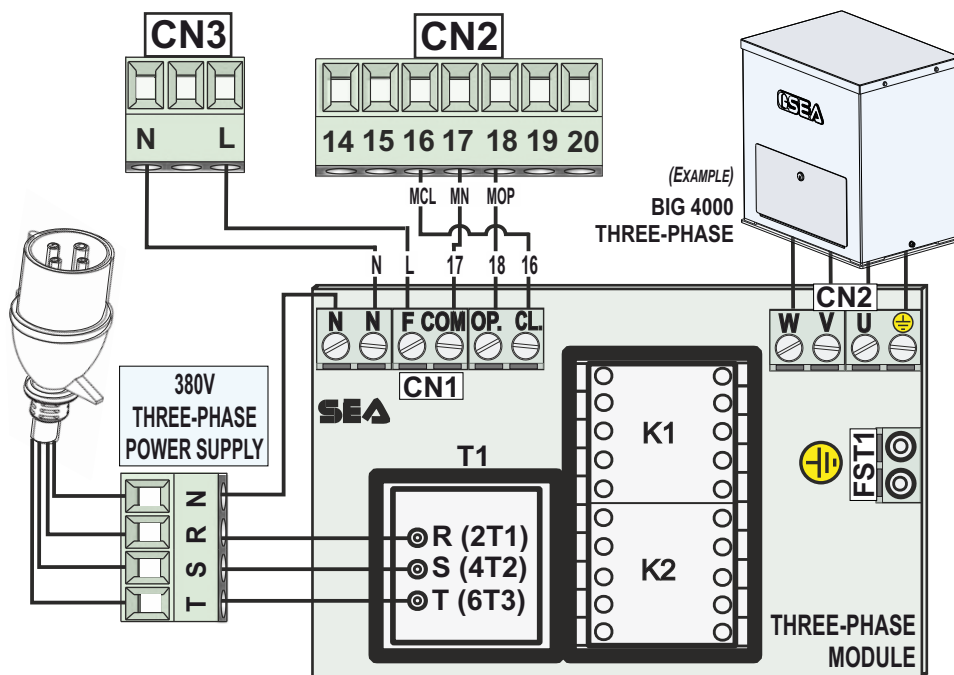

- For the use of three-phase operators with three-phase module, it is necessary to set menu 3 on «THREE-PHASE/BOLLARD»

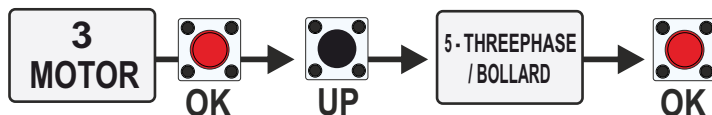

#### 3.3 - COURTESY LIGHT CONNECTION

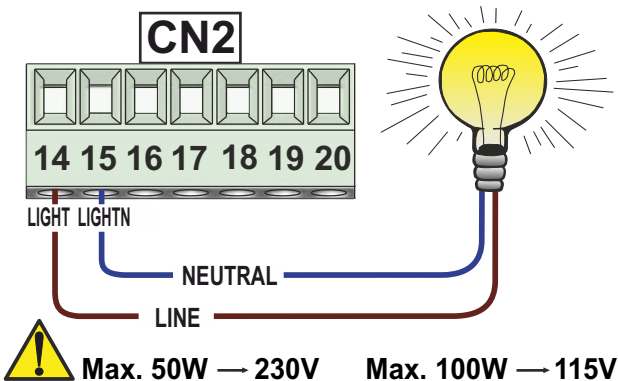

- Wire the courtesy light as shown in the diagram
- Courtesy light operation can be managed by menu 88

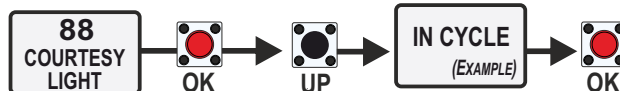

- The timing can be set from 0 to 240 seconds

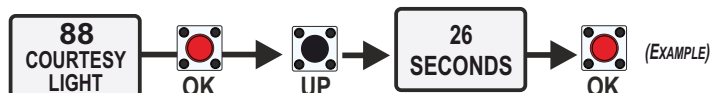

## 4 - POWER SUPPLY CONNECTION ON CN3

### 4.1 - CONTROL UNIT POWER SUPPLY

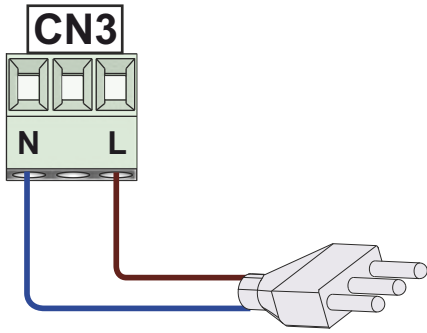

- Fuse 16AT delayed on 230V~ power supply  
Fuse 16AT delayed on 115V~ power supply
- Use a 10A differential switch to protect the power supply system
- In case of unstable power supply, the use of an external UPS of min.800VA is recommended



**For the connection to the power grid respect the laws in force**



**The control unit must be powered only after all the wirings have been completed!**

## 5 - CONNECTION ON CN4

### 5.1 - 24VAC CONNECTOR (MAX 150 mA)

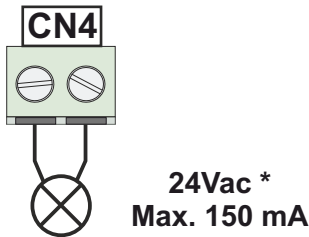

- The electronic unit is equipped with a 24Vac connector, with a maximum load of 150 mA, for connecting 24V accessories such as the external receiver, the external power supply or additional photocells, etc..

### 5.2 - SYNCHRONIZED PHOTOCELLS CONNECTIONS

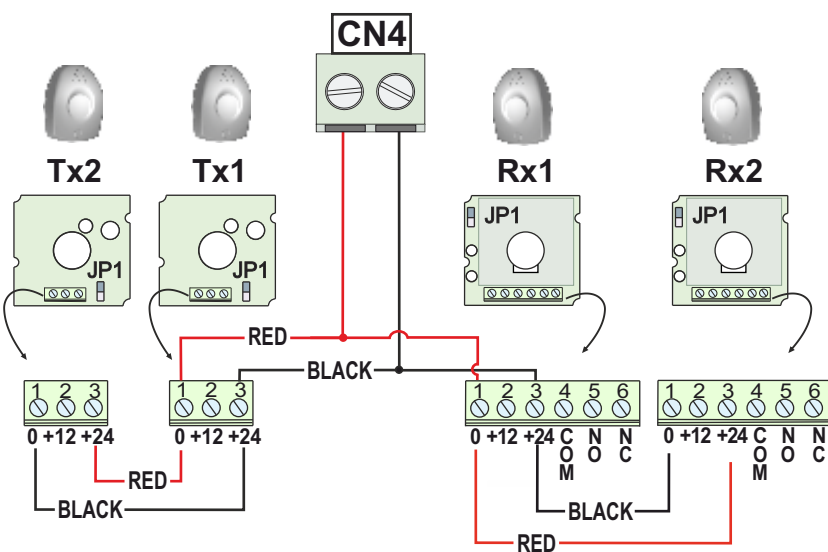

**JP1 «ON» = SYNCHRONIZATION ENABLED**

- Wiring diagram for one or two couple of synchronized photocells on CN4 (24Vac-max. 150 mA)
- Set the desired operation mode via the menus «photocell»

**97**  
PHOTOCELL  
1

**98**  
PHOTOCELL  
2

➔ For more details on synchronized photocells, see the relative technical instruction

## 6 - CONNECTIONS ON CN5

### 6.1 - STANDARD ENCODER CONNECTION

- Connect the ENCODER on CN5; respect the cable color
- Encoder can be enabled on menu 32

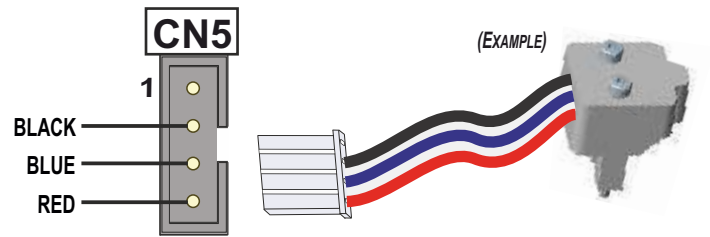
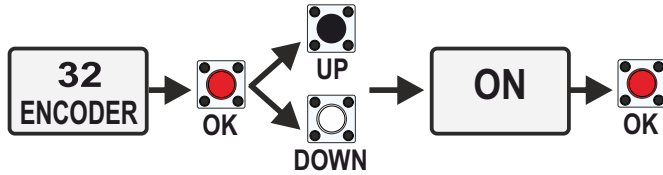

- The menu 47 shows the impulses read during the operation
  - The menu 48 shows the total pulses stored during the learning
- ⇒ *The menus 47 - 48 are visible only when the menu 32 is «ON»*

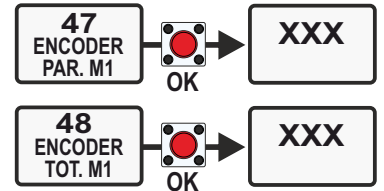

### 6.2 - ENCODER PARAMETERS ADJUSTMENT

- Settable values: minimum 10% (rapid intervention) - maximum 99% (slow intervention)
- ⇒ *If set to OFF (intervention excluded), the encoder only detects position*

- Opening intervention time adjustment

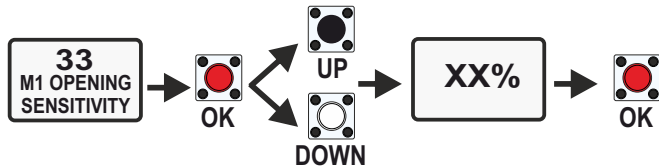

- Closing intervention time adjustment

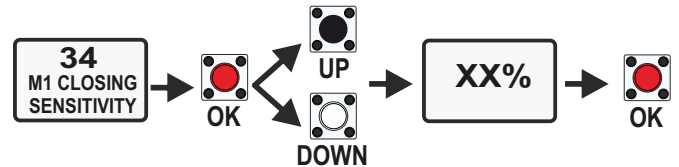

## 7 - CONNECTION ON CN6 and CN7

### 7.1 - LIMIT SWITCH CONNECTION

- Connect the opening and closing limit switch as shown in the diagrams below according to the type of limit switch in use: **PRE-WIRED LIMIT SWITCH on CN6** or **NON PRE-WIRED LIMIT SWITCH on CN1 and CN7**

⇒ The type of limit switch in use is automatically detected during the working times learning

**The ANTI-INTRUSION FUNCTION is also available;** It is linked to the limit switch activation; If enabled through the menu 79, this function restores the original position of the gate after a manual forcing or a blast of wind

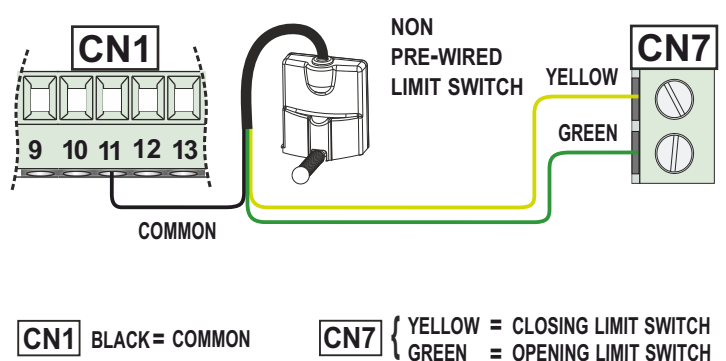
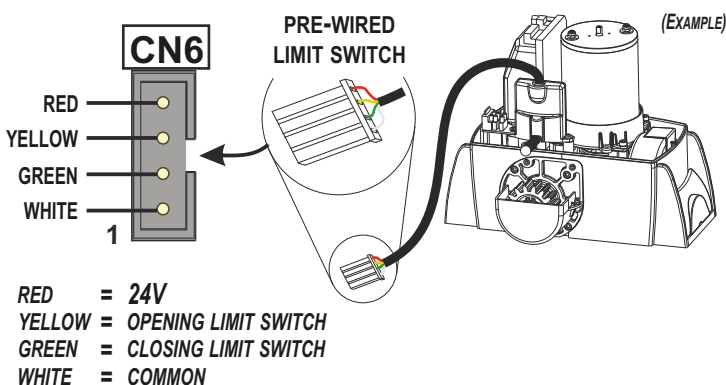
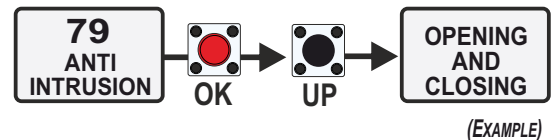

## 8 - CONNECTION ON CMS

### 8.1 - «PRIMARY/SECONDARY» (MASTER/SLAVE) CIRCUITS

- PRIMARY/SECONDARY mode: to manage 2 operators (ex. opposite barriers or bollards) having each one its control unit
- Wire each «PRIMARY/SECONDARY» circuit to the CMS connector of each control unit
- Management via menu 105; set a control unit as «PRIMARY» and the other as «SECONDARY»

**105**  
 PRIMARY  
 SECONDARY

➔ Connect all accessories on the «PRIMARY» control unit. The «SECONDARY» control unit only allows the management of the following menus:

1-LANGUAGE	47-MOTOR 1 PARTIAL ENCODER	72-MOTOR 1 TOLERANCE IN OPENING
3-MOTOR	48-MOTOR 1 TOTAL ENCODER	73-MOTOR 1 TOLERANCE IN CLOSING
5-REVERSE MOTOR	59-MOTOR 1 SLOWDOWN IN OPENING	76-PUSHING STROKE
14-RESET	60-MOTOR 1 SLOWDOWN IN CLOSING	83-EXTRA TIME
28-MOTOR 1 OPENING TORQUE	63-DECELERATION	86-FLASHING LIGHT
29-MOTOR 1 CLOSING TORQUE	64-ACCELERATION	88-COURTESY LIGHT
32-ENCODER	65-MOTOR 1 OPENING TIME	94-24V AUX (NO AUTOTEST FUNCTION)
33-MOTOR 1 OPENING SENSITIVITY	66-MOTOR 1 CLOSING TIME	104-SELECT LIMIT SWITCH
34-MOTOR 1 CLOSING SENSITIVITY	70-POSITION RECOVERY IN OPENING	106-DIAGNOSTICS
37-SLOWDOWN SENSITIVITY	71-POSITION RECOVERY IN CLOSING	112-PASSWORD

### 8.2 - «PRIMARY/SECONDARY» CONFIGURATION

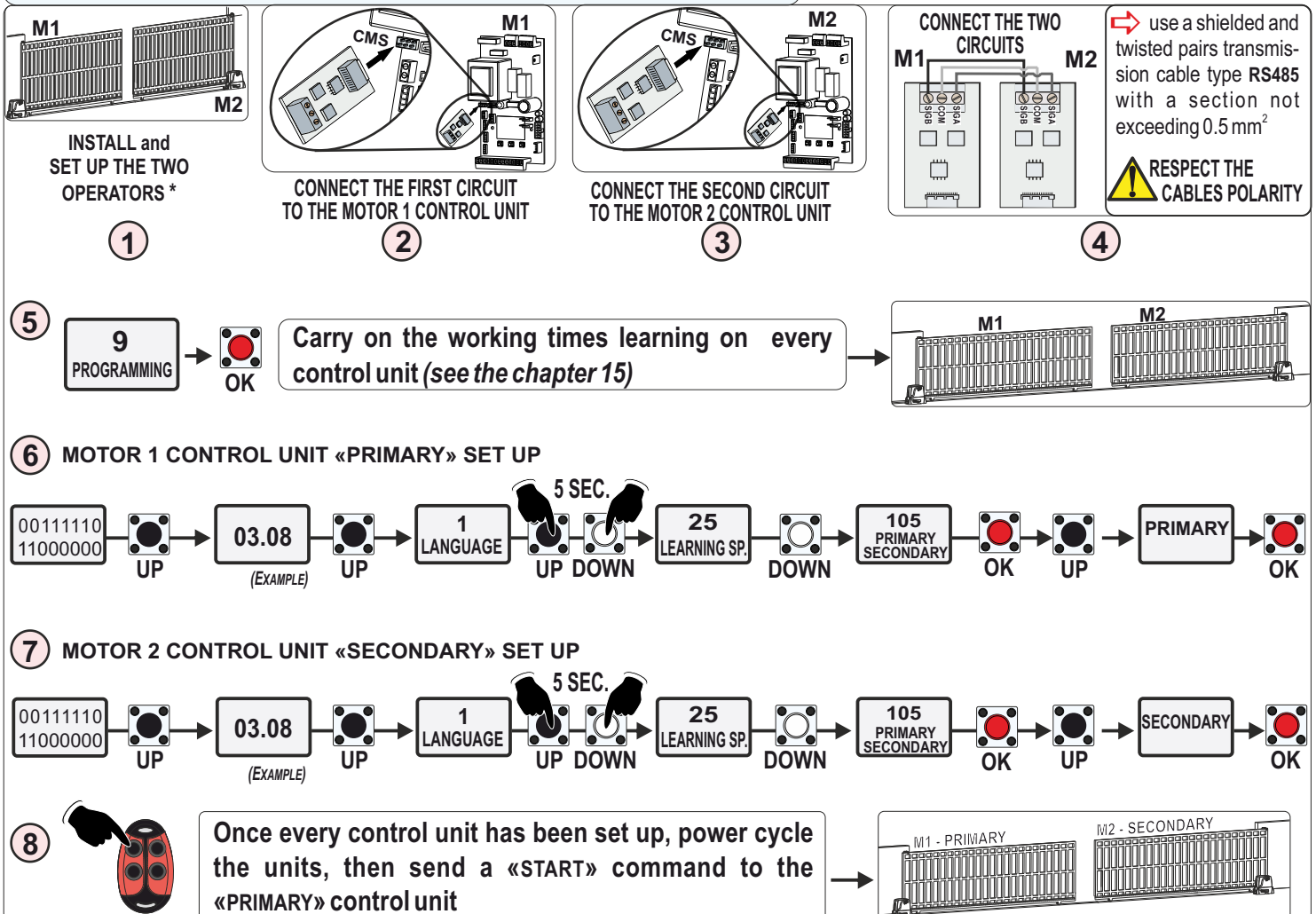

\* Install and set up the two operators as if they were two independent installations. check the correct functioning and the correct reading of the limit switches, if installed.

## 9 - CONNECTIONS ON EXP

### 9.1 - «SEM 2» MANAGEMENT UNIT

24V~ / = (ac/dc)  
or 230V~

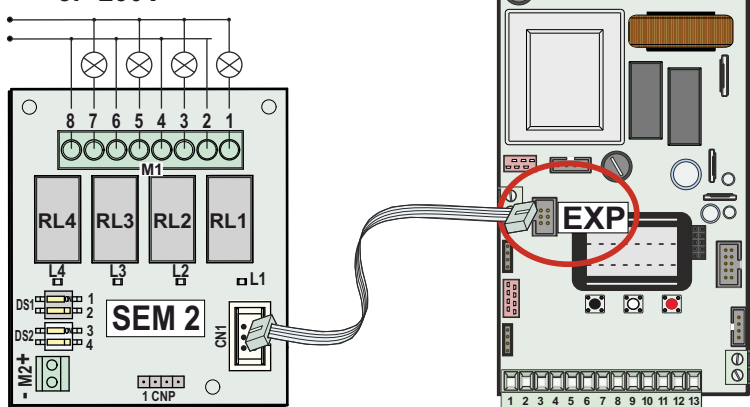

● The SEM 2 accessories management unit allows you to connect and manage the following additional accessories:

- TRAFFIC LIGHT
- COURTESY LIGHT
- VERTICAL ELECTRIC LOCK
- POSITIVE OR NEGATIVE ELECTRIC BRAKE

➔ **SEM2 READS THE LIMIT SWITCHES STATUS**  
(to connect those accessories whose activation depends on the limit switches status)

**More details on SEM 2 instructions**

### 9.2 - «LSE» or «LE» or «LRT» MANAGEMENT UNITS

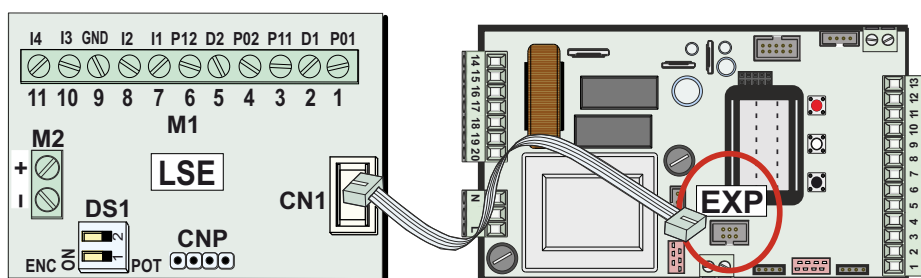

● The LSE (or LE) or LRT management circuits allow you to connect and manage different additional accessories, such as the temperature probe or the potentiometer or the RT encoder

**More details on LSE (or LE) or LRT instructions**

### 9.3 - TEMPERATURE PROBE CONNECTION VIA «LSE» or «LE» UNITS

● The probe detects the oil temperature; If it falls below the set threshold, the probe activates the heating, returning the values to the established range

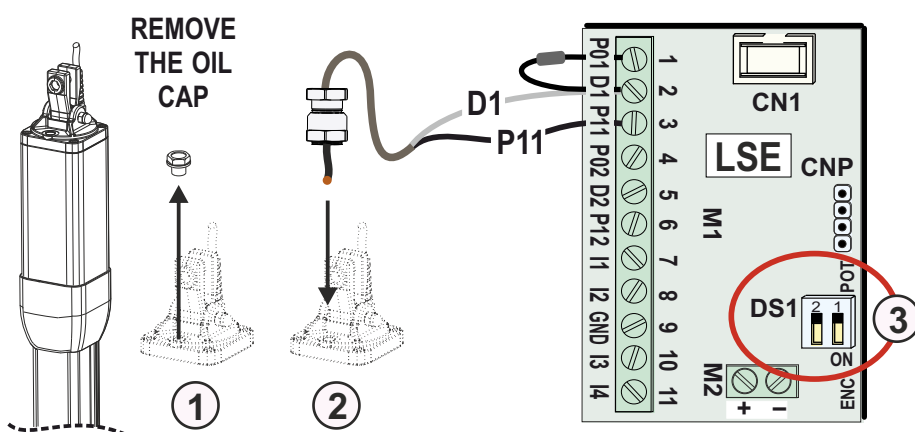

① *Remove the oil cap*

② *Screw the temperature probe to replace the oil cap*

③ *Set both DIP-SWITCH to OFF*

DIP SWITCH 1 = OFF OFF  
DIP SWITCH 2 = OFF ON

D1 = WHITE P11 = BLACK

### 9.4 - ACTIVATION AND SETTING OF THE TEMPERATURE PROBE

● To enable the probe: menu 109

● Setting of the HIGH and LOW TEMPERATURE THRESHOLDS, to enable or disable the oil heater

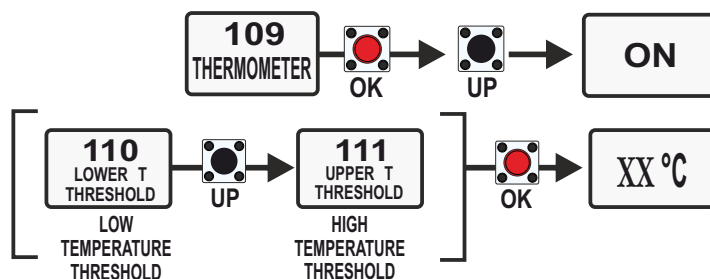

### 9.5 - «POSITION GATE» LINEAR POTENTIOMETER CONNECTION VIA «LSE» or «LE»

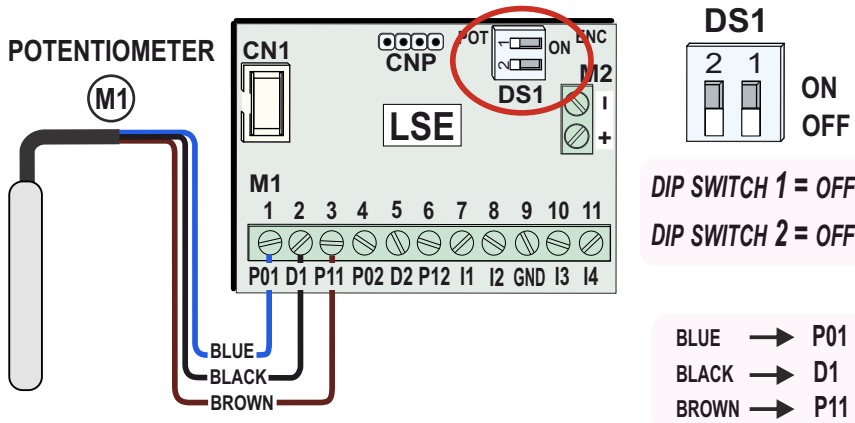

- Connect the «POSITION GATE» linear potentiometer for managing the correct position of the gate and the inversion on obstacles, as shown aside

- Respect the cable colors

⇒ **The use of a 3-pole shielded cable is recommended - wire the shield on P11**

- To enable the linear potentiometer:

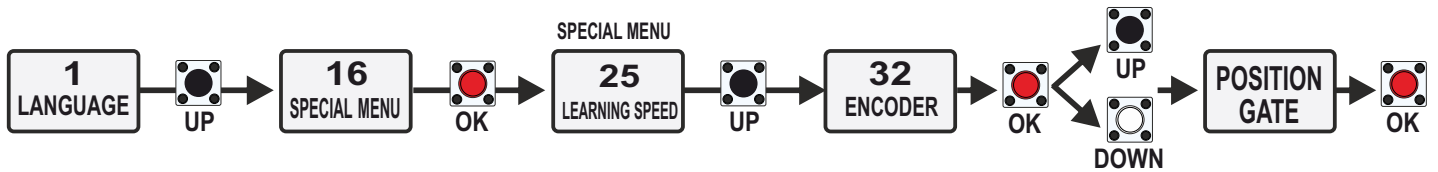

**i** The menus 51 - 52 - 53 will be visible only if the potentiometer is enabled; the menus allow pulses to be displayed and adjusted - **paragraph 9.7**

### 9.6 - «RT» ABSOLUTE ENCODER CONNECTION VIA «LRT» CIRCUIT

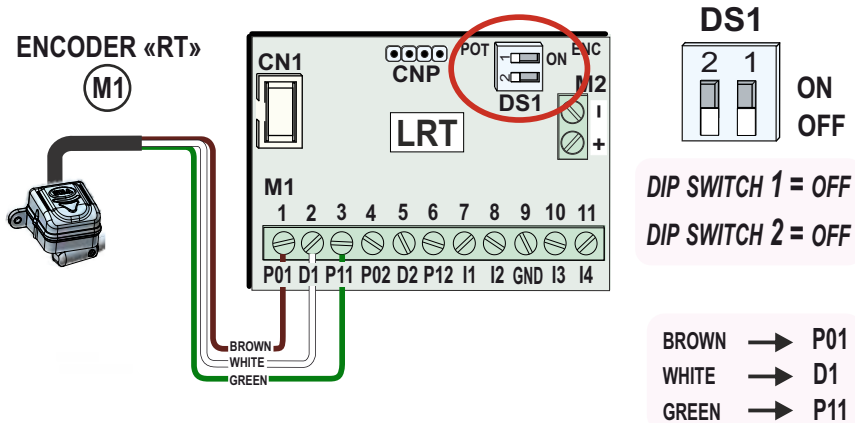

- Connect the «RT» ABSOLUTE ENCODER, for managing the correct position of the gate and the inversion on obstacles, as shown aside

- Respect the cable colors

⇒ **The use of a 3-pole shielded cable is recommended - wire the shield on P11**

**i** If an operator equipped with «RT» encoder is set in the 3-MOTORS menu, the special menu 32 will not be visible as the unit automatically sets to «RT»

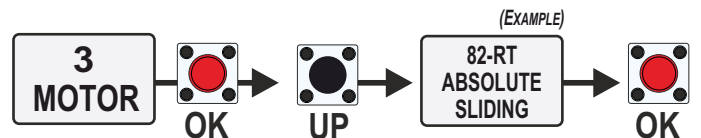

On the other hand, menus 51 - 52 - 53 will be visible, which allow pulses to be displayed and adjusted **paragraph 9.7**

**i** **The ANTI-INTRUSION FUNCTION is also available;** It is linked to the potentiometer or the «RT» encoder activation; If enabled via menu 79, this function restores the original position of the gate after a manual forcing or a blast of wind

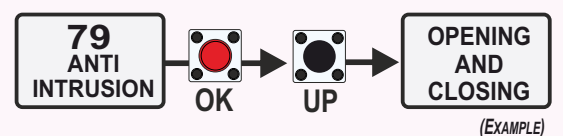



## 9.7 - LINEAR POTENTIOMETER or «RT» ABSOLUTE ENCODER CONFIGURATION

⇒ *The menus 51-52-53 are visible only when the menu 32 is set to «POSITION GATE» or ENCODER «RT»*

● **MENU 51: motor 1 partial impulses**  
to display the operator current position

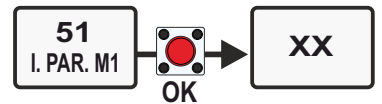

● **MENU 52: motor 1 opening impulses**  
to display the impulses when the gate is completely open;  
possibility to increase or decrease the total pulses

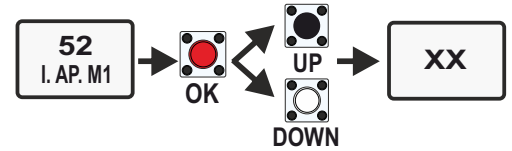

● **MENU 53: motor 1 closing impulses**  
to display the impulses when the leaf is completely closed;  
possibility to increase or decrease the total pulses

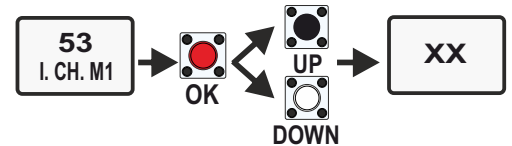

## 9.8 - POTENTIOMETER or «RT» ENCODER PARAMETERS ADJUSTMENT

● Sensitivity parameters in opening and closing for potentiometer intervention time adjustment

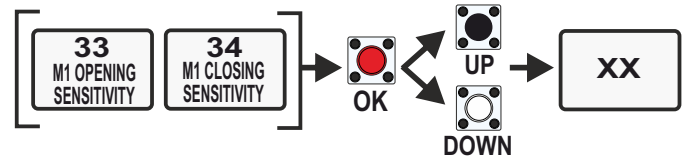

⇒ *For a quick reverse on obstacle decrease the sensitivity*

ⓘ *Set to OFF (intervention excluded): merely detection of the impulses (does not reverse on obstacle)*

● Slowdown sensitivity menu to adjust the inversion time during the slow down

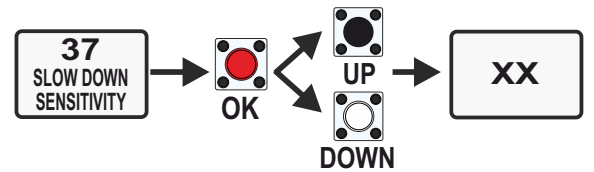

⇒ *For a quick reverse on obstacle decrease the sensitivity*

● To adjust the Encoder intervention threshold values in opening and closing

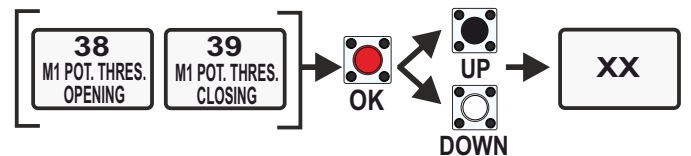

⇒ *The lower the threshold, the greater the force required for the inversion*

● To adjust the threshold values for the Encoder intervention during the slow down, in opening/closing

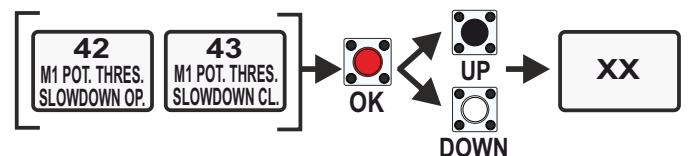

⇒ *The lower the threshold, the greater the force required for the inversion*

## 9.9 - ACCESS TO THE HIDDEN «DEBUG» MENU

● To display the instantaneous speed value detected «VP1» (Motor 1); knowing this value allows you to adjust the intervention thresholds of the potentiometer in opening, in closing and during the deceleration (see previous paragraph).



**The thresholds must always be adjusted to a greater value than the «VP1» value shown!**

# 10 - RECEIVERS CONNECTION ON CNA and CNS

RF UNI  
RF UNI PG

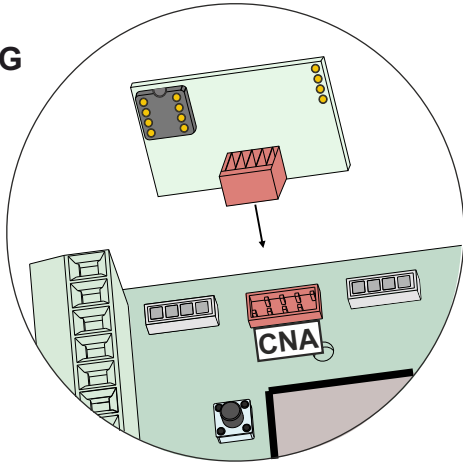

RF FIX

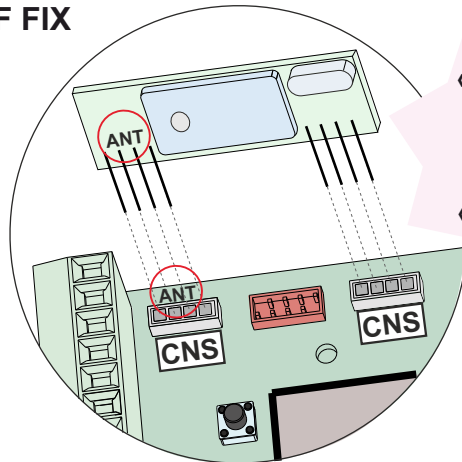

«RF FIX» RECEIVER IS STANDARD (ON BOARD) ON THE MODEL «GATE 1 DG R2EF»



Respect the plug-in direction of the receivers circuits;

RF FIX: the «ANT» contacts printed on the receiver and the unit circuits, must match!

## 10.1 - «MEMO» ADDITIONAL MEMORY - ONLY ON MODEL «GATE 1 DG R3BF»

- The «GATE 1 DG R3BF» model is designed for the plug-in of the additional «MEMO» memory, which allows you to store up to 496 users if combined with the «RF FIX» receiver (which normally stores only up to 16 users!)

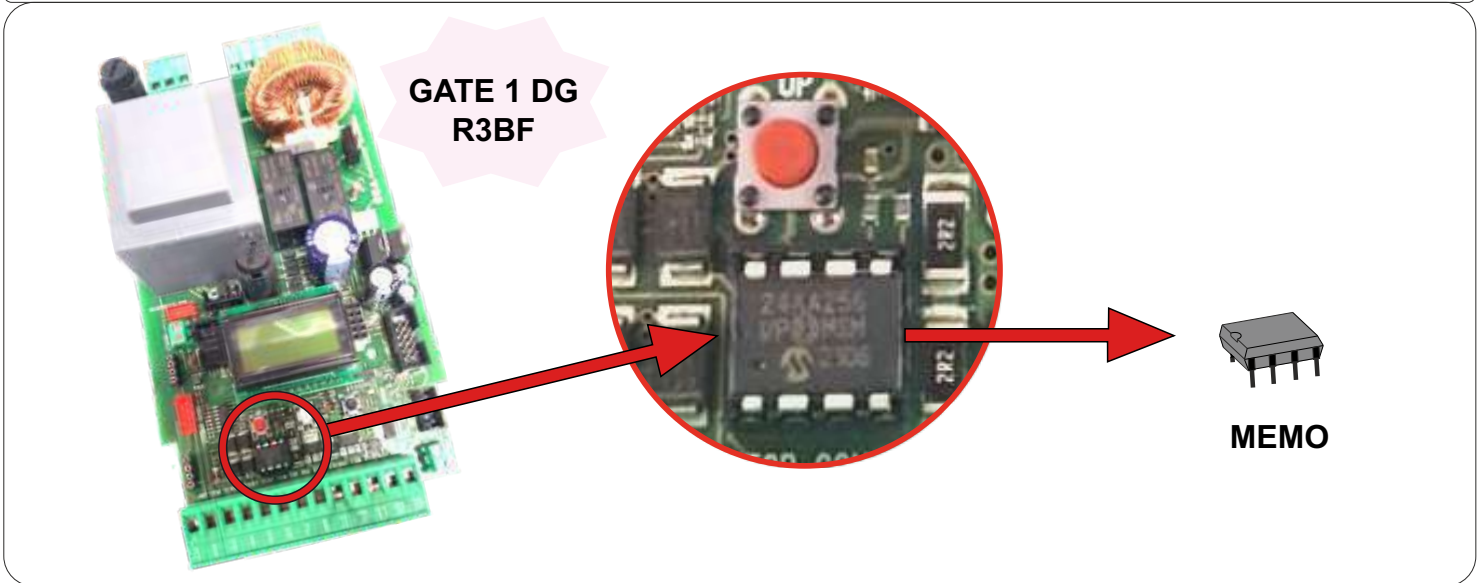

SEA PLUG-IN RECEIVERS	MAX. USERS NUMBER
RF UNI	16 USERS Without additional memory 800 USERS With <b>MEMO</b> additional memory
RF UNI PG (Old Model - Non extractable memory)	100 USERS Fix code 800 USERS Roll plus
RF UNI PG (New Model - Extractable memory)	496 USERS Fix code 800 USERS Roll plus
RF FIX	16 USERS Without additional memory 496 USERS With <b>MEMO</b> additional memory

# 11 - ADDITIONAL FUNCTIONS

## 11.1 - AMPEROMETRIC MANAGEMENT - ONLY FOR ELECTROMECHANIC OPERATORS with GATE 1 DG R2BF

- Obstacle detection system with inversion both in OPENING and CLOSING
- Set the menu 37 on a value different from OFF (which is set by default) to enable the function

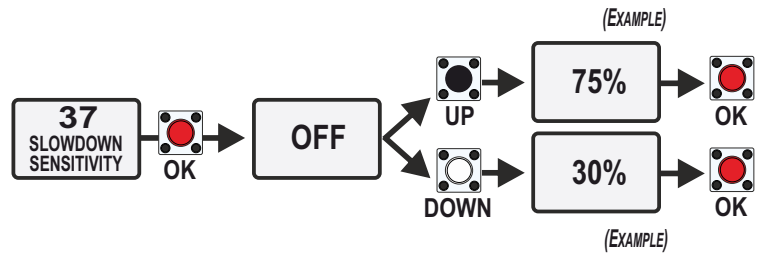

⇒ the greater the value, the greater the amperometric intervention delay

- Torque parameters setting in opening and closing for adjustment of the inversion force on obstacle

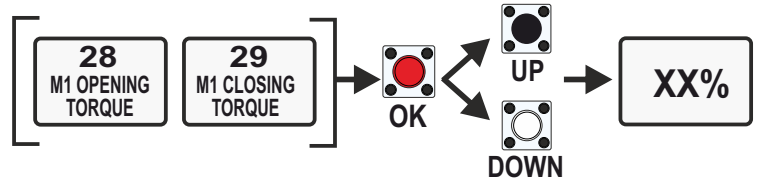

⇒ the greater the torque, the greater the force required for the inversion

- Sensitivity parameters in opening and closing for the amperometric intervention time adjustment

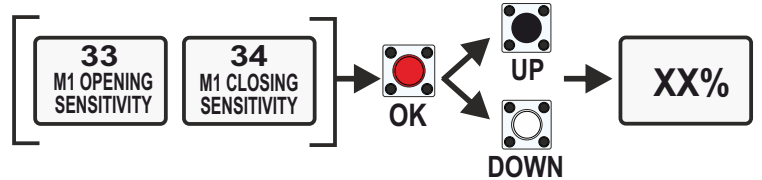

⇒ for a quick reverse on obstacle decrease the sensitivity

**i** If set to OFF (intervention excluded) the amperometric management will only work according to the menu 37 settings

## 11.2 - AMPEROMETRIC INTERVENTION METHOD

- Choice between total or partial reclosing after the amperometric intervention (menu 46)

**46**  
CLOSING  
INVERSION

⇒ When the menu 46 is set to «TOTAL» and the menu 7 is different from OFF, the «AUTOMATIC RECLOSING» function automatically enables: in case of obstacle the operator tries to reclose up to 5 times, then a new START command will be required to restore the motion.

**7**  
TIMER TO  
CLOSE

**i** After a power failure, the first cycle will be performed at pre-set speed to detect the mechanical stops

## 11.3 - «I/O SURGE PROTECTOR» CIRCUIT CONNECTION

- To protect up to 6 inputs and the 24V power supply from temporary overloads (ie. lightning strikes)

- Connect the 24VDC cable and the accessories cables on **input**; connect the corresponding cables from **output** to the control unit

**!** Connect the negative and the common cables from the main power supply to the control unit

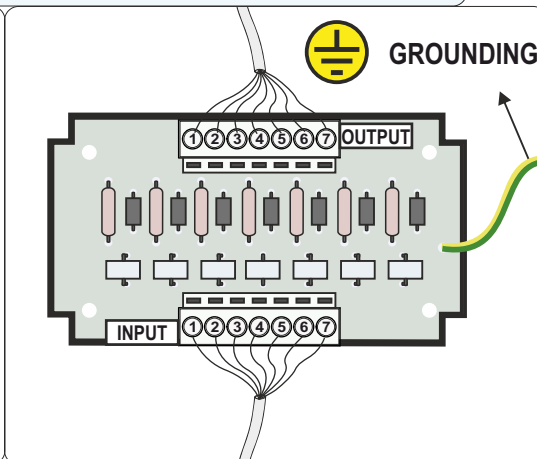

### OUTPUT CONNECTION ON CONTROL UNIT

- 1 24V DC ACCESSORIES
- 2 CONTACT 1 (Es. PHOTOCELL)
- 3 CONTACT 2 (Es. SAFETY EDGE)
- 4 CONTACT 3 (Es. START)
- 5 CONTACT 4
- 6 CONTACT 5
- 7 CONTACT 6

### INPUT ACCESSORIES CONNECTION

- 1 24V DC ACCESSORIES
- 2 CONTACT 1 (Es. PHOTOCELL)
- 3 CONTACT 2 (Es. SAFETY EDGE)
- 4 CONTACT 3 (Es. START)
- 5 CONTACT 4
- 6 CONTACT 5
- 7 CONTACT 6

# 12 - DISPLAY and PROGRAMMING

**CONNECT ALL THE ACCESSORIES WHEN THE CONTROL UNIT IS SWITCHED OFF! AFTER ALL CONNECTIONS HAVE BEEN MADE, POWER ON THE UNIT FOR SETTINGS**

## 12.1 - POWER ON THE CONTROL UNIT

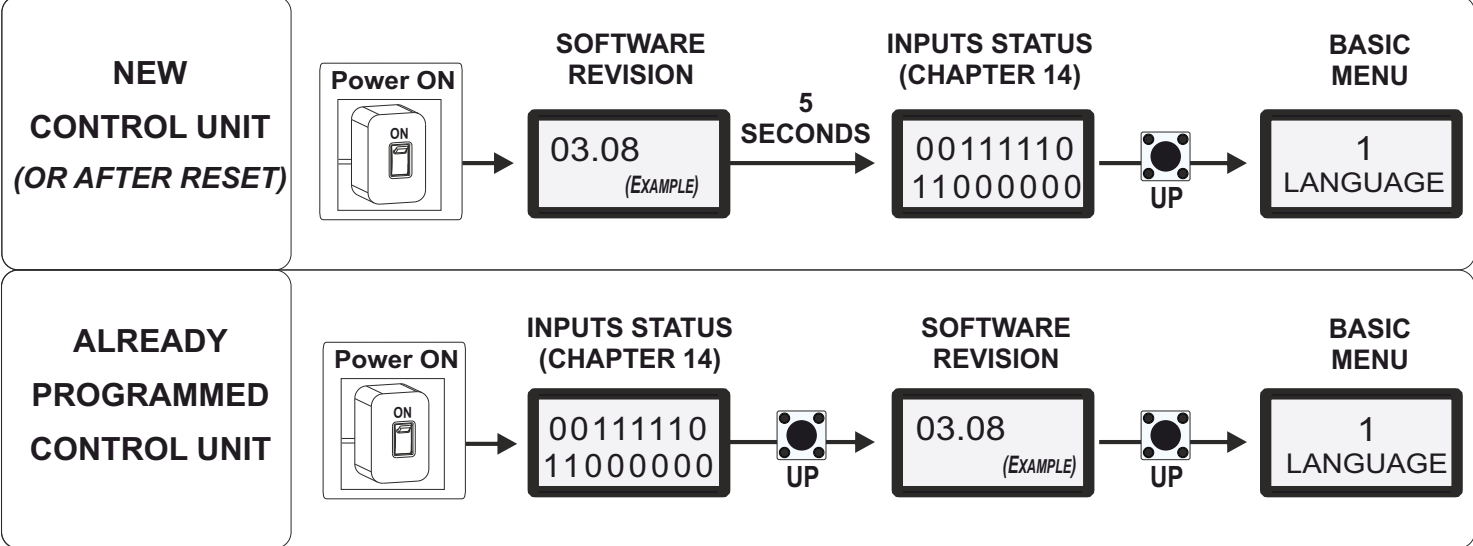

## 12.2 - BASIC MENU and SPECIAL MENU

- The control unit has a **BASIC MENU** (*chapter 13*) which allows the basic settings in order to start using the product quickly - *see chapter 15*
- The **SPECIAL MENU** allows to change default settings, or to enable/disable the accessories or the control unit functions
- To access the **SPECIAL MENU** use one of the two following methods

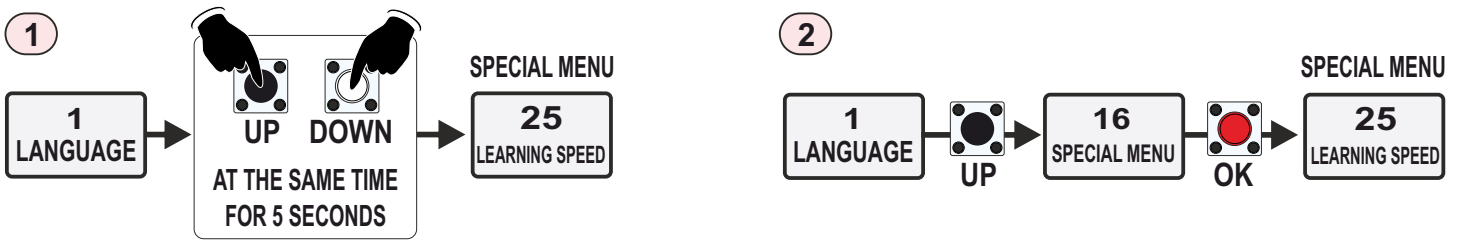

**IN THE BASIC MENU IT IS POSSIBLE TO SELECT THE OPERATOR TYPE IN USE AND OTHER NECESSARY OPTIONS. ONCE THE TYPE HAS BEEN CHOSEN, ALL THE SPECIAL MENUS ARE AUTOMATICALLY SET TO THE DEFAULT VALUES USEFUL FOR THAT OPERATOR, SO FURTHER SETTINGS MAY NOT BE NECESSARY**

# 13 - BASIC MENU

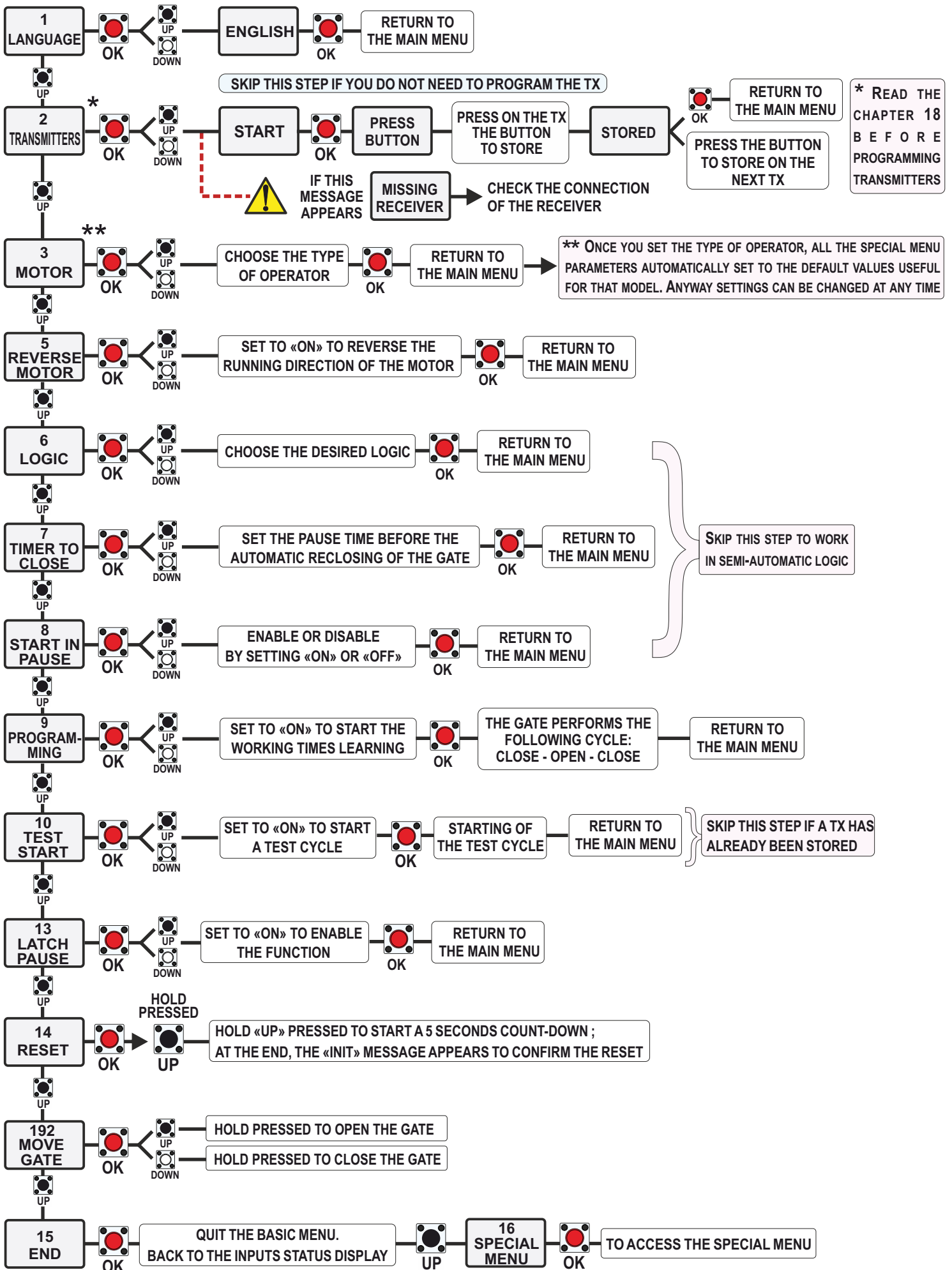

# 14 - INPUTS STATUS MANAGEMENT

- Every input corresponds to a fixed position on the display, according to the diagram below
- Every input can be: **NORMALLY OPEN (0)** - **NORMALLY CLOSED (1)**

**0** N.O. - NORMALLY OPEN

**1** N.C. - NORMALLY CLOSED

<p>1 2 3 4 5 6 7 8</p> <p>↑ ↑ ↑ ↑ ↑ ↑ ↑ ↑</p> <div style="border: 2px solid black; padding: 10px; text-align: center;"> <p>00111110</p> <p>11000000</p> </div> <p>↓ ↓ ↓ ↓ ↓ ↓ ↓ ↓</p> <p>9 10 11 12 13 14 15 16</p>	<p>1 START (*)</p> <p>2 PARTIAL START</p> <p>3 STOP</p> <p>4 PHOTOCELL 1</p> <p>5 PHOTOCELL 2</p> <p>6 SAFETY EDGE 1</p> <p>7 SAFETY EDGE 2</p> <p>8 NOT IN USE</p>	<p>9 MOTOR 1 OPENING LIMIT SWITCH</p> <p>10 MOTOR 1 CLOSING LIMIT SWITCH</p> <p>11 NOT IN USE</p> <p>12 NOT IN USE</p> <p>13 NOT IN USE</p> <p>14 NOT IN USE</p> <p>15 NOT IN USE</p> <p>16 NOT IN USE</p>
---	---	--

\* If a **TIMER** is connected to the **START** input, it keeps the contact normally closed; in this case the display will show «T» on position n° 1

● Example: if you give a «START» command, its input switches from normally open to normally closed

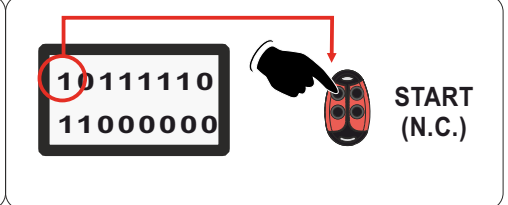
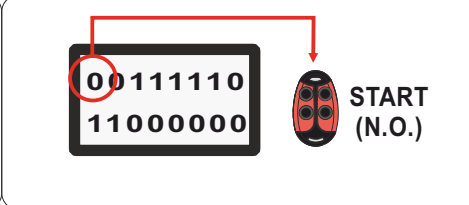

● Example: if you pass by the photocell, its input switches from normally closed to normally open

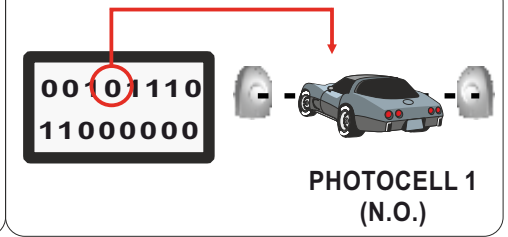
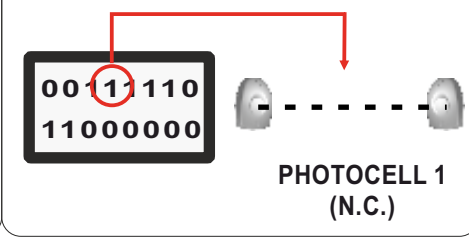

## 14.1 - ACCESS TO THE INPUTS MANAGEMENT MENU

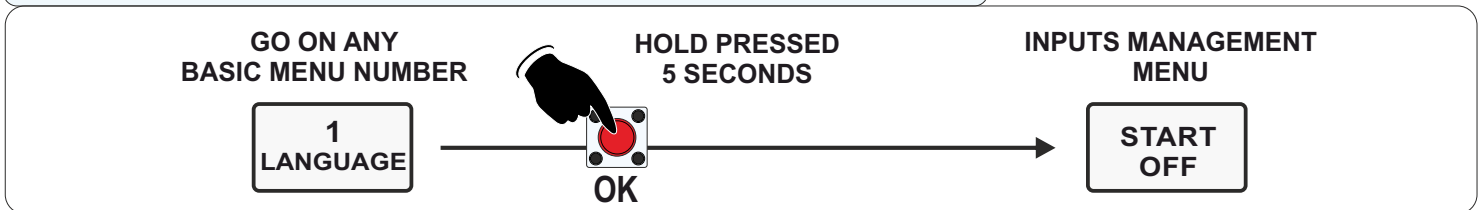

● The «inputs management menu» shows the inputs in their current status: ON or OFF

(EXAMPLE)

START OFF

(EXAMPLE)

STOP ON

● Inside the «INPUTS MANAGEMENT MENU» it is possible to enable or disable the inputs; *paragraph 14.2*

● **START** and **PARTIAL START** are **NORMALLY OPEN (N.O.)** contacts  
 If «ON» is displayed when the contact is activated, then the input works  
 If «OFF» is displayed when the contact is activated, then check the wirings



● **ALL OTHER CONTACTS** are **NORMALLY CLOSED (N.C.)** contacts  
 If «OFF» is displayed when an accessory is wired, then the input works  
 If «ON» is displayed when an accessory is wired, then check the wirings



➔ *THE LIMIT SWITCHES INPUTS CANNOT BE MANAGED, BUT ONLY DISPLAYED IN THEIR CURRENT STATE (ON OR OFF)*

## 14.2 - INPUTS MANAGEMENT MENU

THIS MENU ALLOWS TO ENABLE OR DISABLE THE INPUTS WITHOUT REPEATING THE WORKING TIMES LEARNING

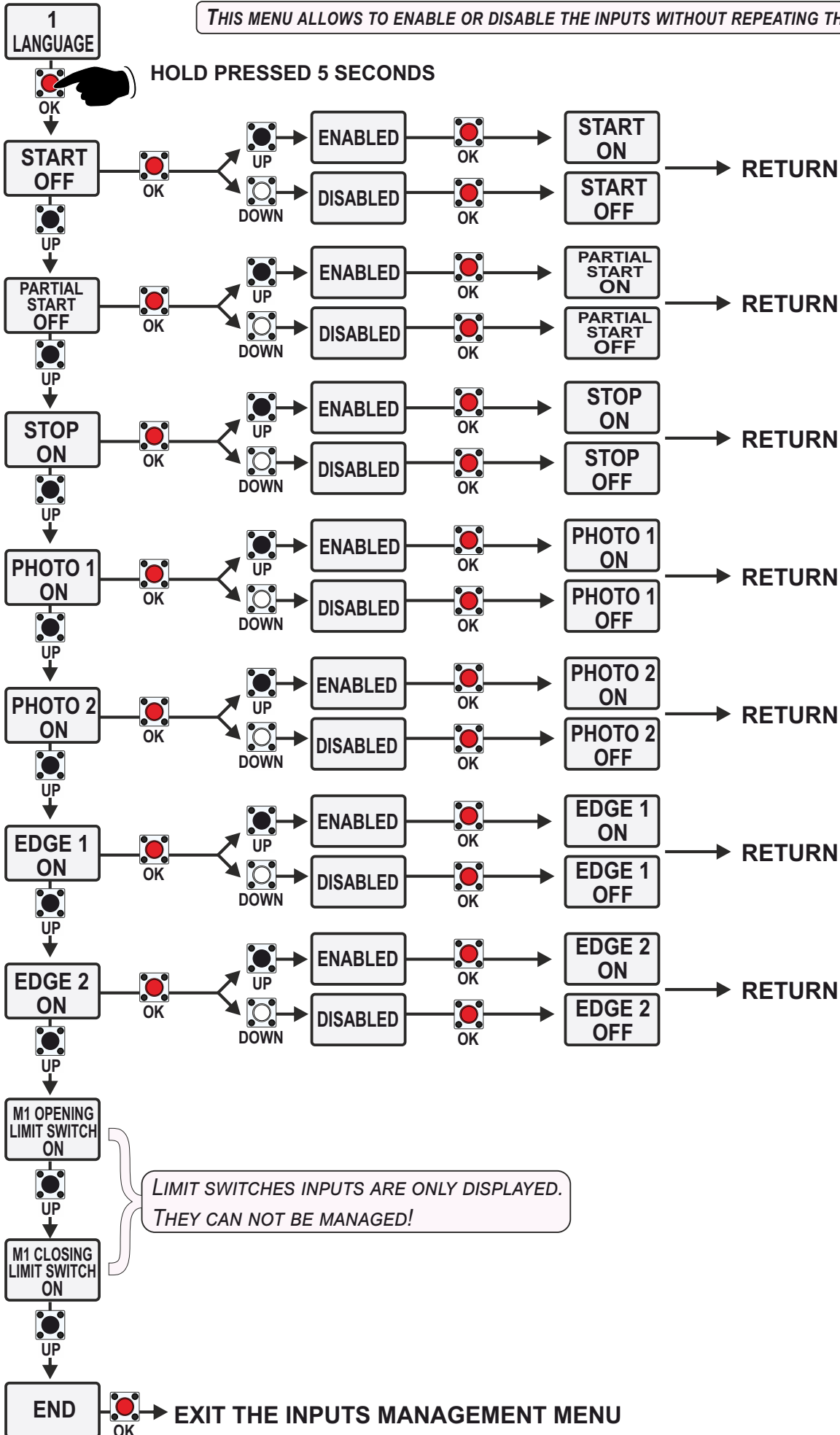

# 15 - WORKING TIMES LEARNING



## DANGER!

**HAVE A QUALIFIED SERVICE PERSON TO CARRY OUT THE OPERATIONS IN SAFE CONDITIONS**

- ⇒ Check the correct operation of all accessories (photocells, buttons, etc.)
- ⇒ Do not jumper the inputs not in use (limit switch, safety edge, etc.)

### 15.1 - PRELIMINARY SETTINGS

⇒ **Before programming the working times, it is necessary to carry out the essential settings of the basic menu. It is not possible to correctly start-up the times learning without carrying-on the following settings!**

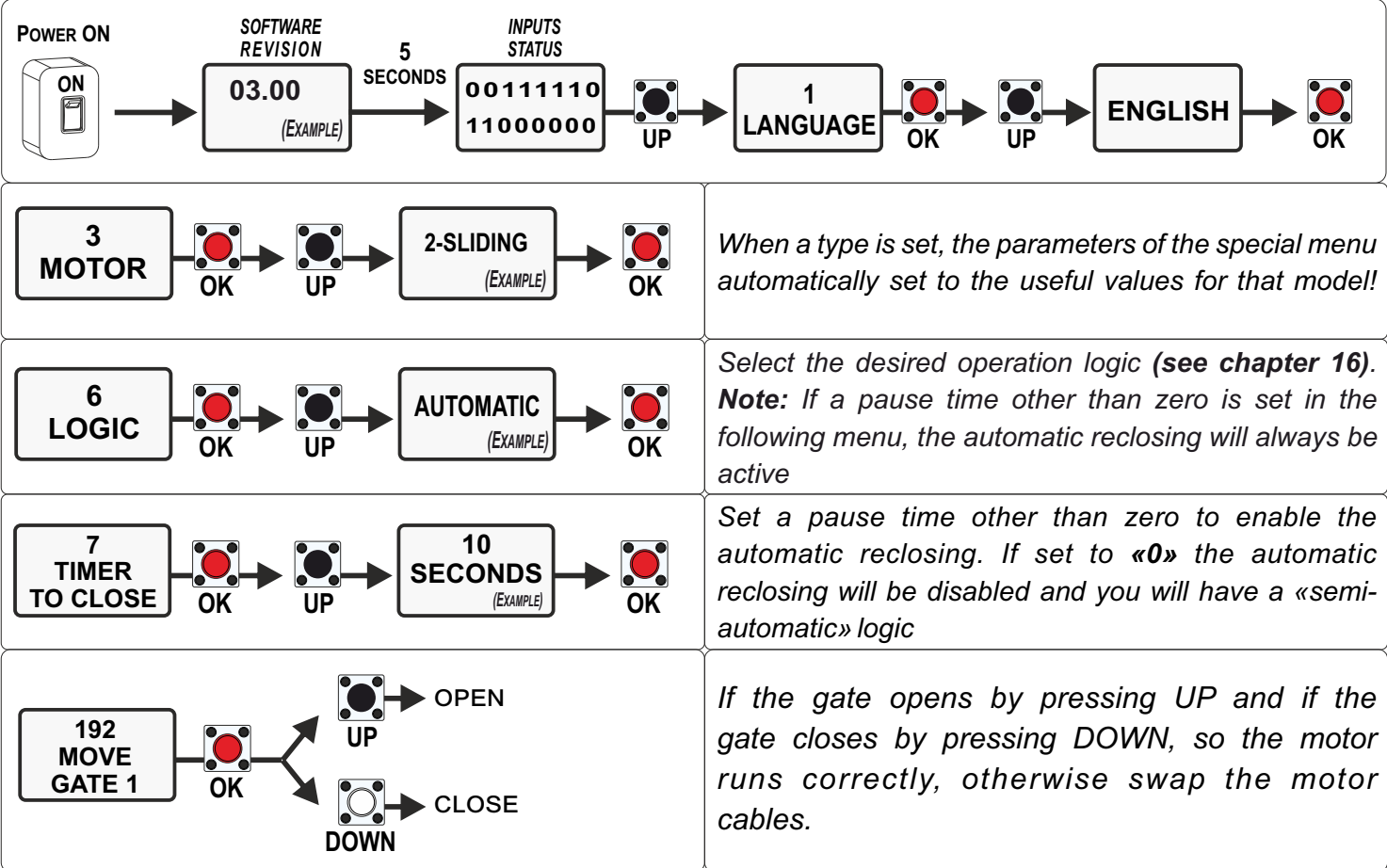

### 15.2 - ENCODER OR POTENTIOMETER ACTIVATION (IF INSTALLED)

● If the operator is equipped with an encoder or potentiometer (*position gate*), then it is necessary to check that they are correctly enabled in special menu 32, **before the working times learning!**

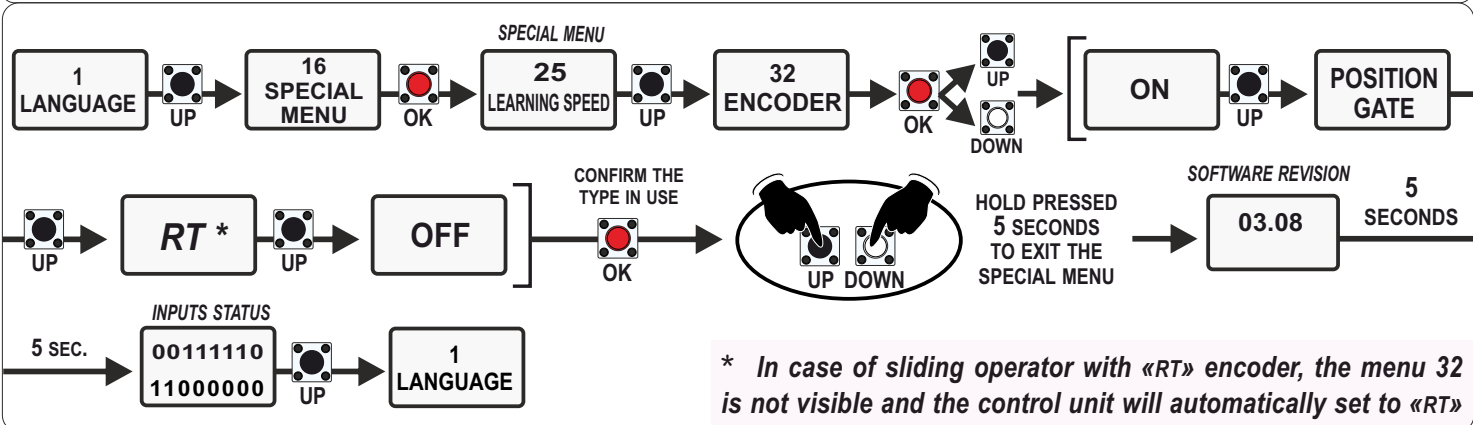



### 15.3 - QUICK LEARNING - ONLY FOR SEA SLIDING OPERATORS

- The control unit on board the SEA sliding operators is pre-set by default (model and parameters) to allow the quick learning of the working times

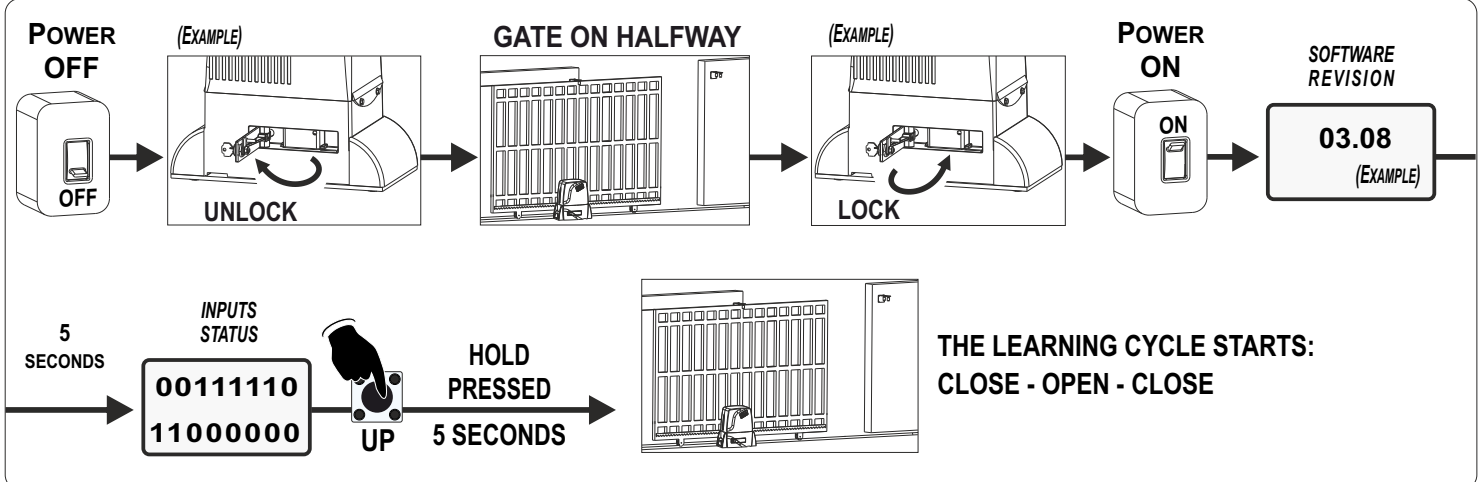

⇒ If the operator performs the first learning cycle starting in opening, wait for the end of the cycle and reverse the motor rotation through the menu 5, then repeat the learning procedure

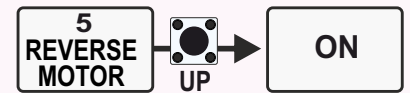

### 15.4 - WORKING TIMES LEARNING BY LIMIT SWITCH

- Working times learning through automatic detection of the limit switches
- Check that the special menu 32 is «OFF» (see paragraph 15.2)
- Check on the **INPUTS STATUS MENU** (chapter 14) that the correct limit switch is engaged for each movement direction
- Start-up the working times learning by following the procedure below:

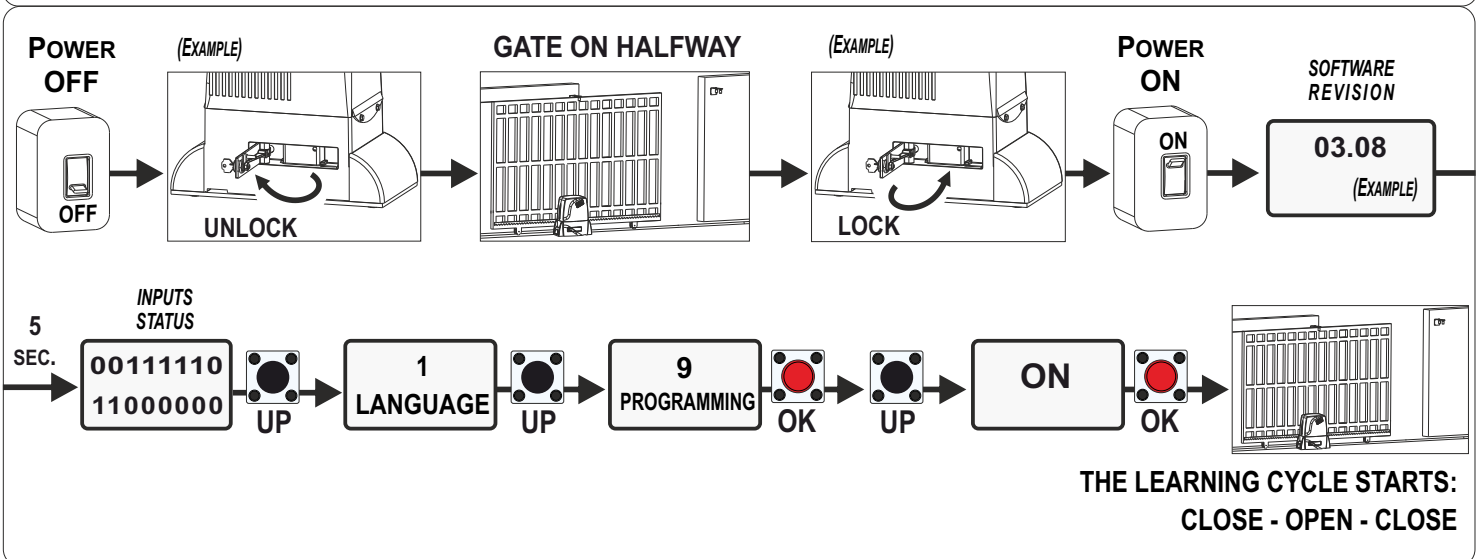

⇒ If the motor starts closing, reaches the limit switch lever and stops, then swap the limit switch cables and repeat the procedure;

⇒ If the motor starts opening, reaches the limit switch lever and stops, then swap the motor cables and repeat the procedure;

## 15.5 - WORKING TIMES LEARNING BY STANDARD ENCODER

- Working times learning through automatic detection of the end-of-stroke points
- Check that the correct encoder type is enabled in special menu 32 (see *paragraph 15.2*)
- Start-up the working times learning by following the procedure below

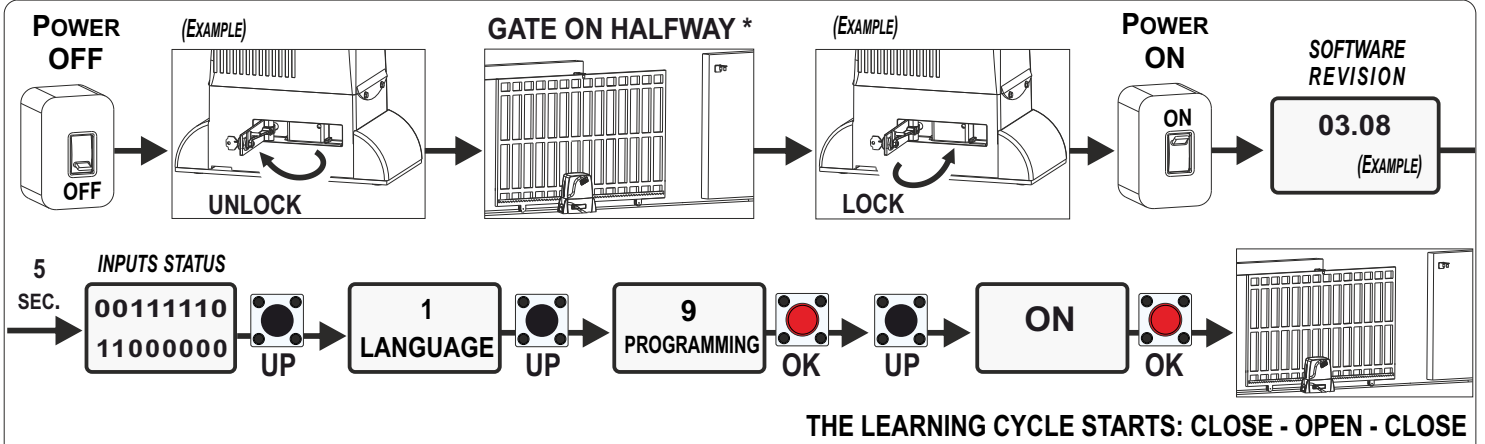

⇒ If the operator performs the first learning cycle starting in opening, wait for the end of the cycle and reverse the motor rotation through the menu 5, then repeat the learning procedure

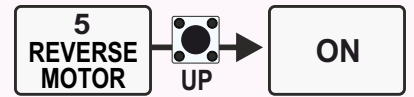

\* In case of barrier, place the arm at approximately 45° (halfway), before starting the learning

- After the learning, it is possible to verify the correct reading of the impulses by accessing the following menus (*paragraph 6.1*)
- After the learning, it is possible to adjust the sensitivity parameters in opening and closing by the following menus (*paragraph 6.2*)

47 ENCODER PAR M1	48 ENCODER TOT M1
33 M1 OPENING SENSITIVITY	34 M1 CLOSING SENSITIVITY

## 15.6 - WORKING TIMES LEARNING BY POTENTIOMETER

- Working times learning through automatic detection of the end-of-stroke points
- Enable the «POSITION GATE» potentiometer in the special menu 32 (see *paragraph 15.2*)
- Start-up the working times learning by following the procedure below

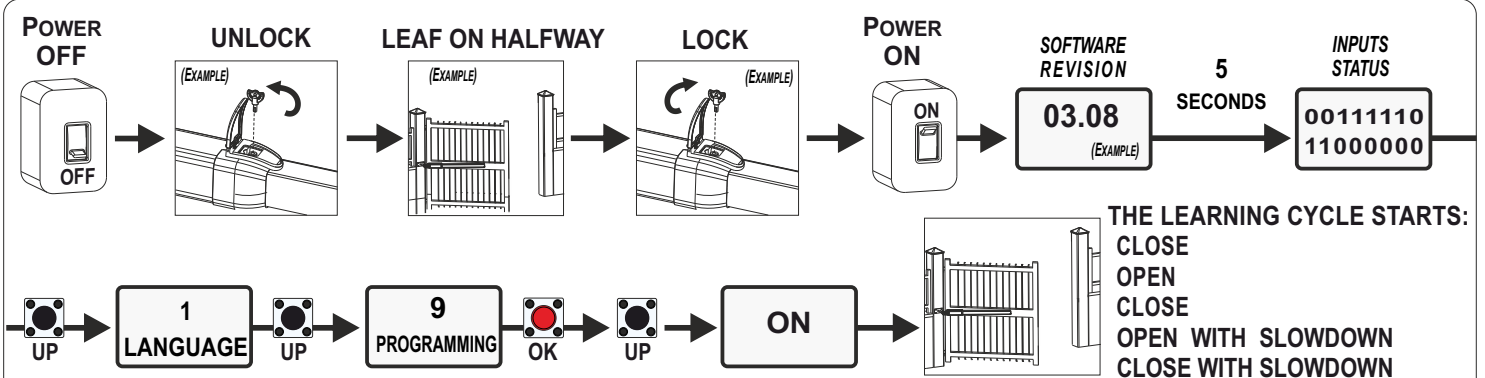

⇒ If the operator performs the first learning cycle starting in opening, wait for the end of the cycle and reverse the motor rotation through the menu 5, then repeat the learning procedure

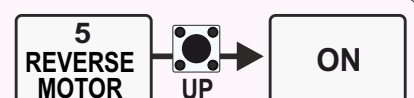

- After the learning, it is possible to check the correct reading of the Impulses by accessing the following menus (see also *paragraph 9.7*)
- After the learning, it is possible to adjust the sensitivity parameters by the following menus (see also *paragraph 9.8*)

51 I. PAR. M1	52 I. AP. M1	53 I. CH. M1
33 M1 OPENING SENSITIVITY	34 M1 CLOSING SENSITIVITY	37 SLOW DOWN SENSITIVITY

⚠ In case the «POTENTIOMETER DIRECTION» alarm is displayed, swap the brown wire with the blue wire and repeat the times learning

## 15.7 - WORKING TIMES LEARNING BY MANUAL PULSES

**FOR OPERATORS WITHOUT LIMIT SWITCH, WITHOUT ENCODER AND WITHOUT POTENTIOMETER (I.E: SWING GATE OPERATORS)**

- Working times learning through manual pulses on the points of stop
- Check that the menu 32 is «OFF» (**paragraph 15.2**); if necessary, adjust the working times by the menus 65 or 66 (*available only when the menu 32 is «OFF»*)

<b>65</b> M1 OPENING TIME	<b>66</b> M1 CLOSING TIME
---------------------------------	---------------------------------

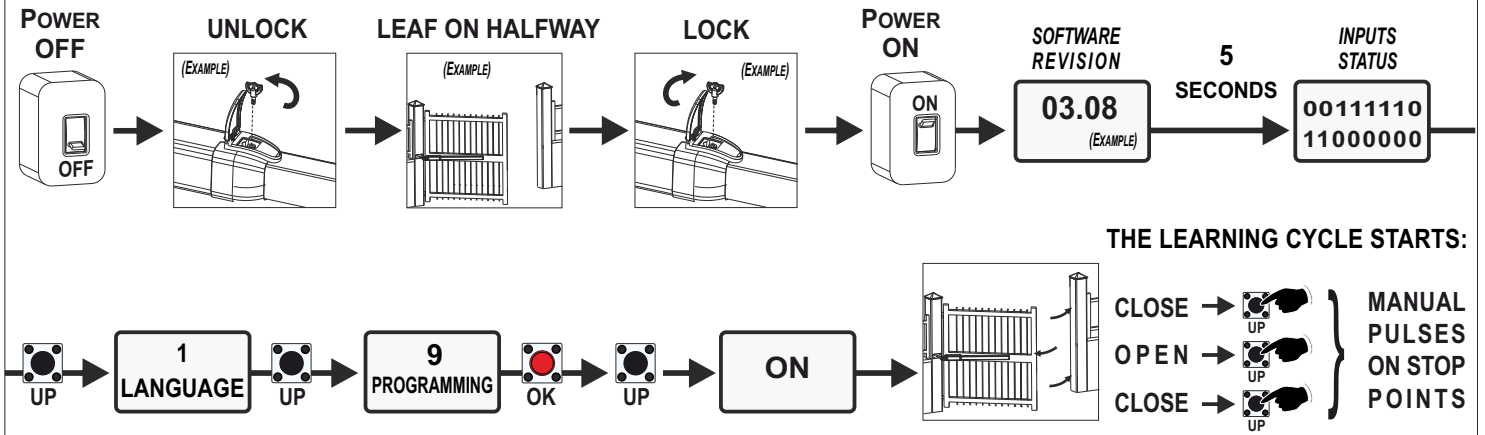

➔ If the operator performs the first learning cycle starting in opening, wait for the end of the cycle and reverse the motor rotation through the menu 5, then repeat the learning procedure

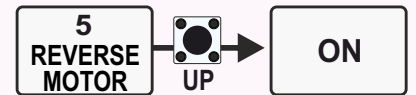

## 15.8 - WORKING TIMES LEARNING BY MANUAL PULSES - with POTENTIOMETER

- Working times learning through potentiometer which detects the manual pulses on the desired points of stop (*allowing the choice of the end-of-stroke points*)
- Enable the «POSITION GATE» potentiometer in the special menu 32 (*see paragraph 15.2*)

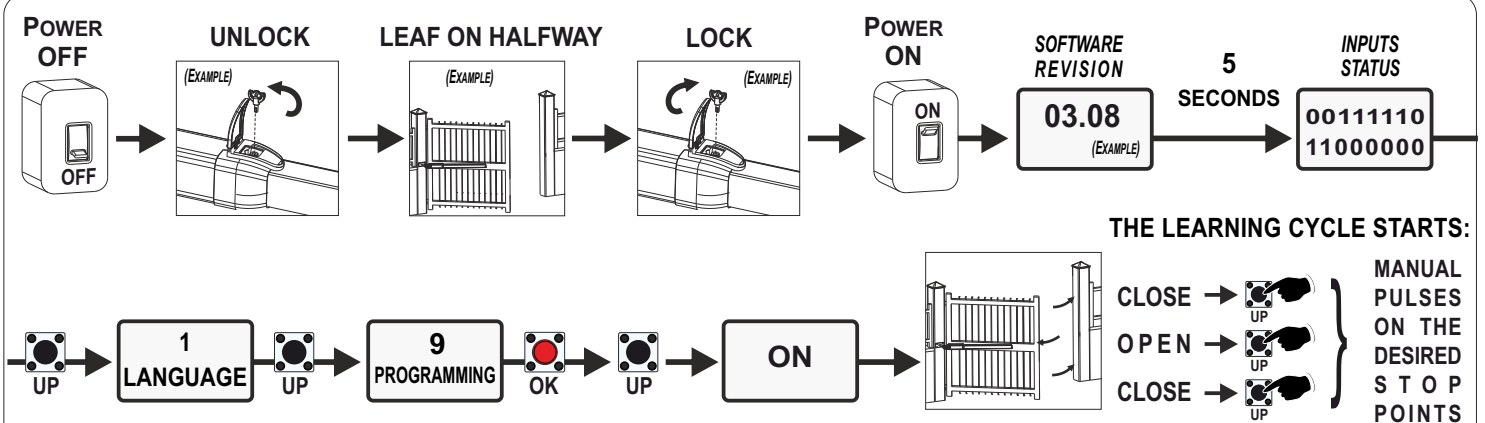

➔ If the operator performs the first learning cycle starting in opening, wait for the end of the cycle and reverse the motor rotation through the menu 5, then repeat the learning procedure

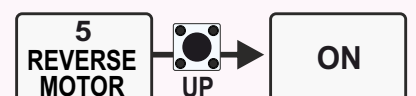

- After the learning, it is possible to check the correct reading of the Impulses by accessing the following menus (*see also paragraph 9.7*)
- After the learning, it is possible to adjust the sensitivity parameters by the following menus (*see also paragraph 9.8*)

<b>51</b> I. PAR. M1	<b>52</b> I. AP. M1	<b>53</b> I. CH. M1
<b>33</b> M1 OPENING SENSITIVITY	<b>34</b> M1 CLOSING SENSITIVITY	<b>37</b> SLOW DOWN SENSITIVITY

In case the «POTENTIOMETER DIRECTION» alarm is displayed, **swap the brown wire with the blue wire and repeat the times learning**

## 15.9 - MANUAL LEARNING - *FOR OPERATORS WITH «RT» ENCODER*

**USE THIS PROCEDURE ONLY ON SLIDING OPERATORS WITH «RT» ENCODER!**

- Check that the correct operator type has been set on the menu 3 (see paragraph 15.1)
- **«RT» Encoder automatically enables** when a «RT» operator is selected on the menu 3 - *par. 15.1*
- Start-up the working times learning by following the procedure below

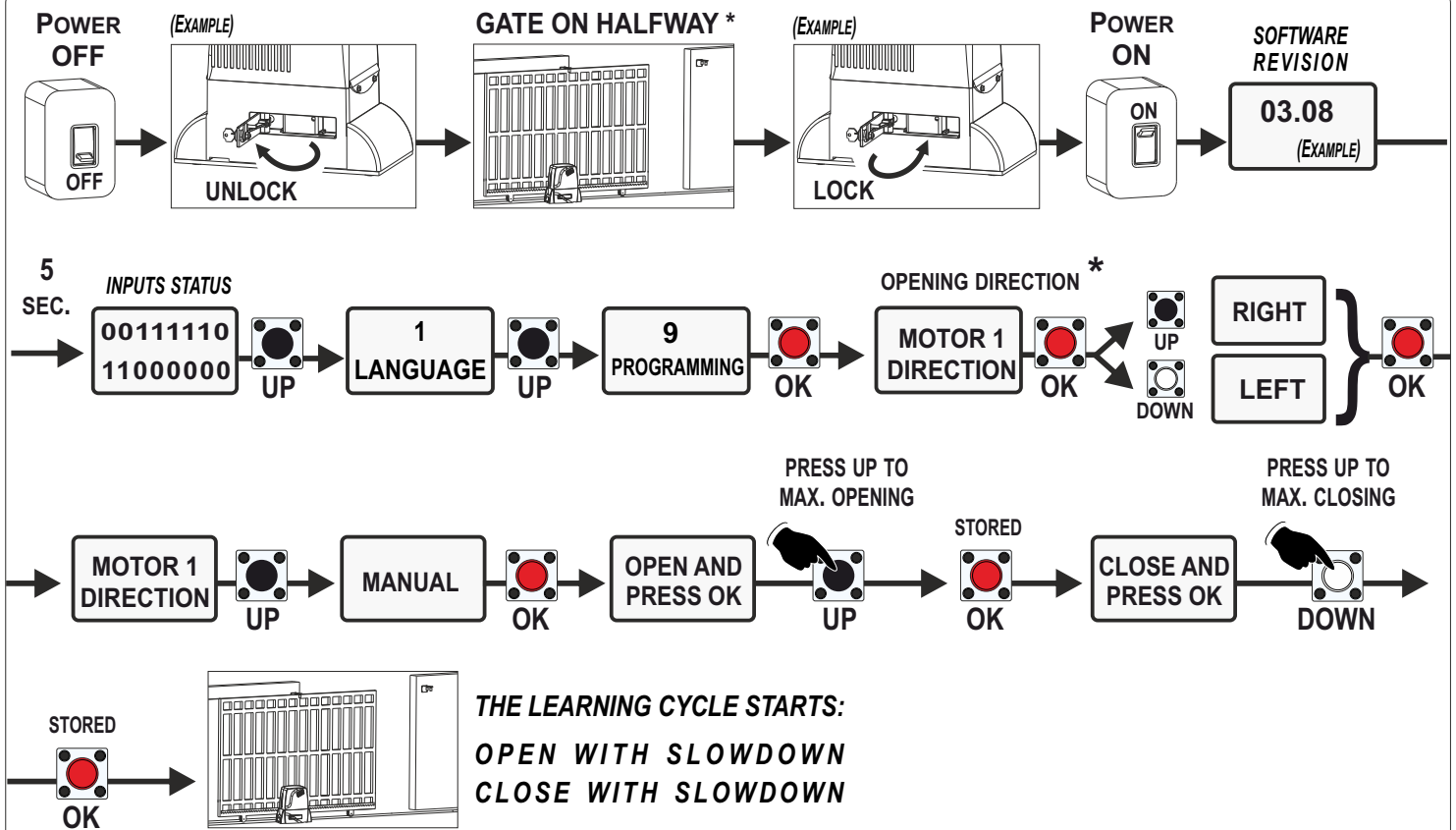

➡ At the end, it is possible to fine-tune the end-of-stroke points by 1 cm pitch through the following menus (visible only if the «RT» Encoder is installed)

<b>52</b> I. AP. M1	<b>53</b> I. CH. M1
------------------------	------------------------

\* By looking at the operator from inside the gate, if the opening is from left to right, then choose the right direction; if the opening is from right to left, then choose left direction

## 16 - LOGICS

**!** THE DEFAULT LOGIC IS «AUTOMATIC», ANYWAY IT CAN BE CHANGED AFTER THE WORKING TIMES LEARNING!

● **SEMI-AUTOMATIC LOGIC:** automatically set when the menu 7 is «OFF» (*automatic reclosing disabled*)

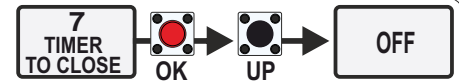

● **SEMI-AUTOMATIC** operation: a **START** command opens the gate; another **START** command closes; *In semi-automatic logic, the automatic reclosing is always disabled.*

● This logic matches with other logics (*except «AUTOMATIC»*), keeping the automatic reclosing disabled

● **AUTOMATIC LOGIC:** pre-set by default. Anyway it can be manually enabled through the menu 6 or through the menu 7 by setting a pause time different than 0 and up to 240 seconds (*The menu 7 also enables the automatic reclosing when different than 0*)

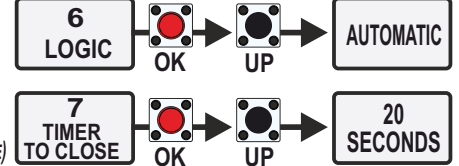

● Through the menu 8 it is possible to choose if the **START** command given during the pause time is accepted or not

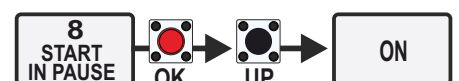

● **AUTOMATIC** operation: a **START** command opens the gate; another **START** command is not accepted if given during the opening; a **START** command reverses the movement if given during the closing

● **SAFETY LOGIC:** a **START** command opens the gate; another **START** command reverses the movement if given during the opening a **START** command reverses the movement if given during the closing

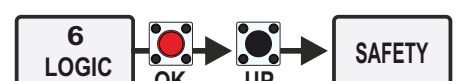

● **STEP BY STEP TYPE 1 LOGIC:** the **START** command follows the logic: **OPEN - STOP - CLOSE - STOP - OPEN**

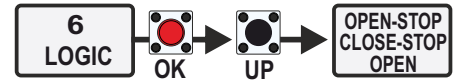

● **STEP BY STEP TYPE 2 LOGIC:** the **START** command follows the logic: **OPEN - STOP - CLOSE - OPEN**

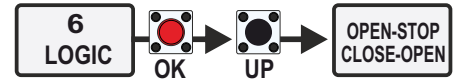

● **DEAD MAN LOGIC:** the gate opens as long as the **START** command is held pressed; when released the gate stops. The gate closes as long as the **PARTIAL START** is held pressed; when released the gate stops.

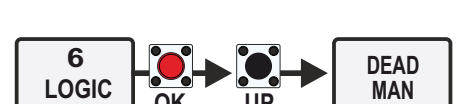

● **2 BUTTONS LOGIC:** a **START** command opens the gate; a **PARTIAL START** command closes the gate

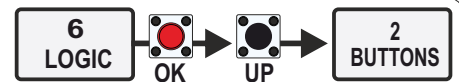

The **START** command reopens the gate if given during the closing. The **PARTIAL START** command is not accepted if given during the opening or during the closing

## 17 - PASSWORD

● Once the password is enabled, all the menus can not be adjusted, they are only displayed

● If you forget the password, contact the SEA technical assistance: **SEA reserves the right to evaluate and decide whether to provide or not the unlocking procedure**

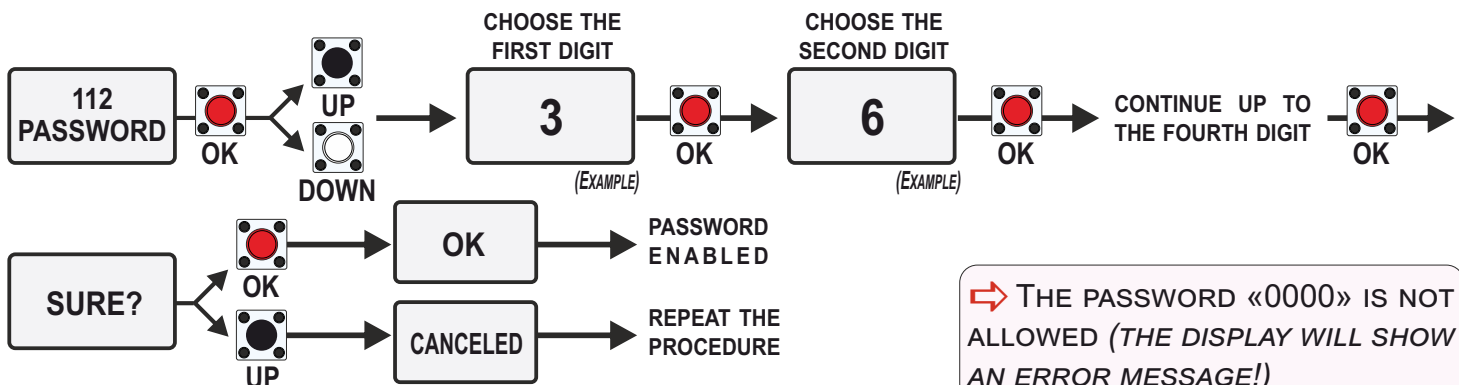

➡ THE PASSWORD «0000» IS NOT ALLOWED (THE DISPLAY WILL SHOW AN ERROR MESSAGE!)

## 18 - RECEIVERS AND TRANSMITTERS

- **When the control unit is switched-off**, check if the receiver is correctly plugged in
- Program the transmitters before connecting the antenna
- Program the transmitters only when the gate is closed and the motor is stopped
- **RF UNI** and **RF UNI PG** allow the use of both **ROLL PLUS/UNI TX** and **FIX CODE TX**
- **RF FIX** allows the use of the **FIX CODE** transmitters only
- It is possible to store up to 2 among the available functions
- The **START** command must **ALWAYS** be stored on the first channel of the TX
- If the second stored function is modified, then all the transmitters acquire this change on the second channel

⇒ **THE FIRST STORED TRANSMITTER DETERMINES THE CODING OF THE FOLLOWING ONES**  
*if the first transmitter is stored as ROLLING CODE, then all the followings must be stored as ROLLING CODE; transmitters with different coding are not accepted - see the coding passage on Tx instruction!*

### 18.1 - OLD «ROLLING CODE» CODING

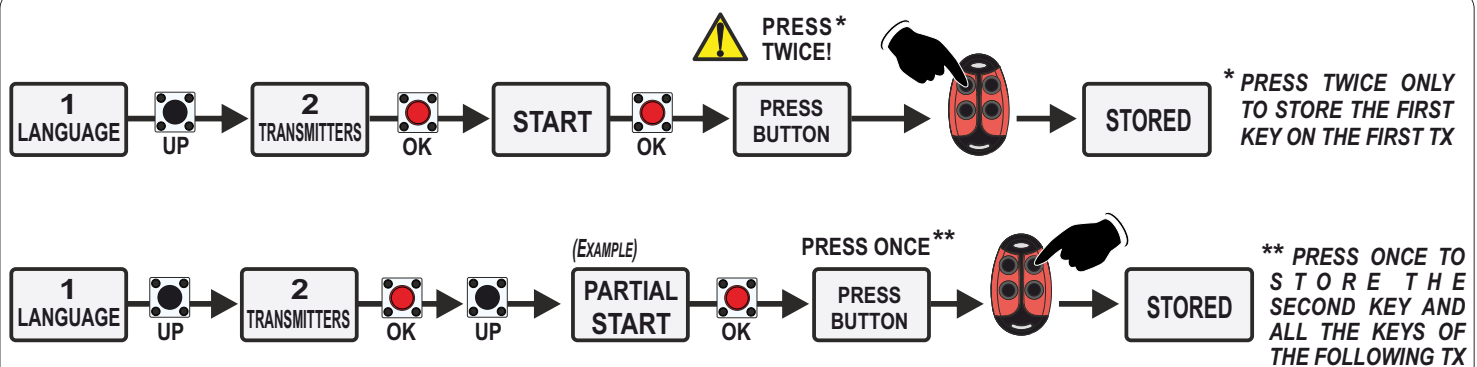

⇒ More details on the functions available in **paragraph 18.4**

### 18.2 - «ROLLING CODE PLUS» - «UNI» - «FIX CODE» TRANSMITTERS

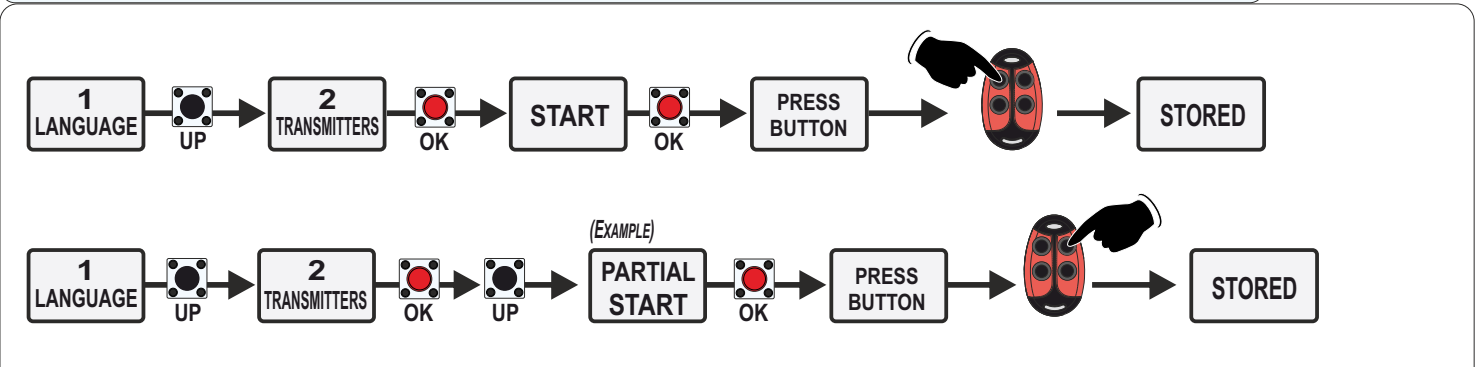

⇒ More details on the functions available in **paragraph 18.4**

### 18.3 - «START» COMMAND QUICK LEARNING

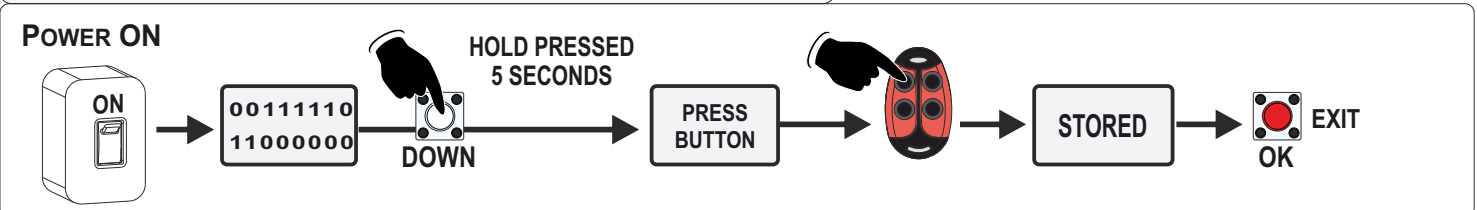

# 18.4 - TRANSMITTERS FUNCTIONS DIAGRAM

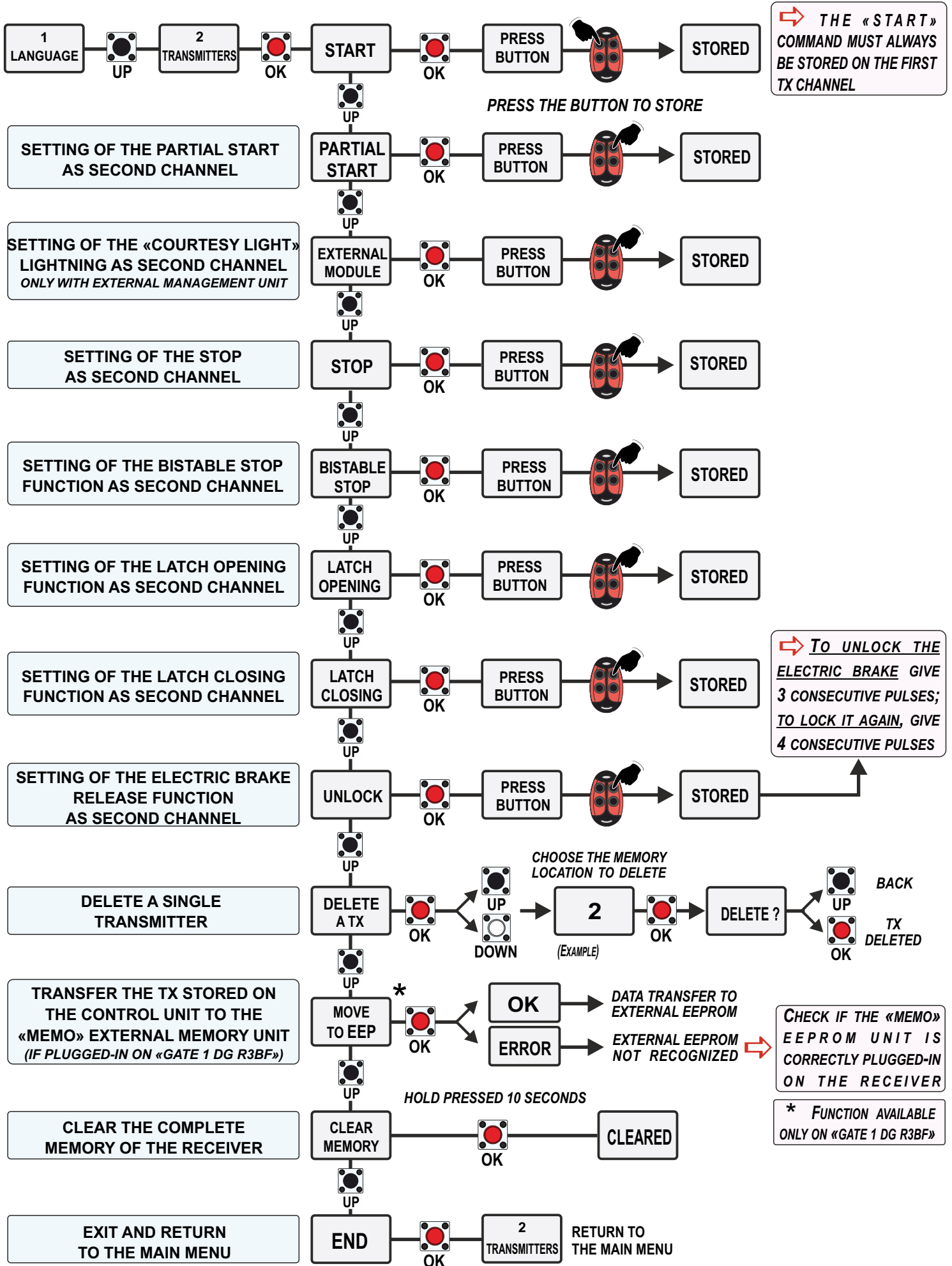

# 19 - ALARMS

## 19.1 - FAULTS SHOWN ON THE DISPLAY

- The control unit advises of the faults may happen through a message on the display (*Note: press ok to exit the message*)
- Below the list of the faults that are signaled on the display and the possible solutions to the problems (*if the fault message holds out, contact the technical support*)

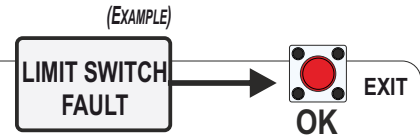

WARNING MESSAGE	SOLUTION
FAULT MOTOR	Motor power supply fault - Check that there are no short circuits on the motor or on the control unit; check that the gate is not blocked or stuck on a stop point. Check that the encoder ( <i>if enabled</i> ) is correctly wired to the control unit. Unlock the operator and give a START command to check that the motor runs: if the motor runs then disconnect the power supply, lock the operator again and restore the power supply; if the motor does not run, then it is burned
FAULT 24	24V power supply fault - Check that there are no short circuits on wirings or on the control unit; check that there is no overload
FAULT 24VAUX CHECK CHARGE ON OUTPUT 10 CONNECT ACCESSORIES OUTPUT12	24VAUX input fault - Check that there are no short circuits on wirings or on the control unit; check that there is no overload. The 24Vaux input is a programmable input and supports a maximum load of 500mA; if you do not need a programmable 24V power supply, use the 24V input on clamp 12(+) and wire the negative cable to the clamp 11 (COM) ( <u>NOT to the clamp 13!</u> )
FAULT NET	Main power supply fault - Check that a power failure is not occurred; check that the main power supply is active; Check the fuse F2
FAULT SELF-TEST	«PHOTOCELLS SELF-TEST» function fault - Check the operation of the photocells and/or their wirings on the control unit
FAULT LIMIT SWITCH	Limit switch activation fault - Check the operation of both limit switches and that there is a correspondence between the direction of movement of the motor and the limit switch engaged
FAULT POTENTIOMETER	Potentiometer fault - <i>The message appears only if the menu 32 is set to «POSITION GATE»</i> - the potentiometer management unit (LE / LSE) is damaged or not correctly wired
FAULT POTENTIOMETER DIRECTION	Potentiometer cable wiring error - Swap the wiring cables of the potentiometer ( <i>swap the blue cable with the brown cable</i> )
FAULT POTENTIOMETER «RT» OR POSITION GATE	Potentiometer fault - <i>The message appears only if the menu 32 is set to «POSITION GATE» or to «RT»</i> the potentiometer management unit (LE/LSE) or the «RT» encoder management unit (LRT) is damaged or not correctly wired
FAULT FLASHING LIGHT	Flashing light fault - Check the wirings and / or the condition of the lamp
FAULT THERMOMETER	Thermometer function fault - <i>The message appears only if the menu 109 is set to «ON»</i> the thermometer management unit (LE / LSE) is damaged or not correctly wired or set
FAULT SLAVE (SECONDARY)	«SECONDARY» ( <i>slave</i> ) function fault - Check that the PRIMARY and the SECONDARY circuits ( <i>master/slave</i> ) are correctly wired to each other and to the control unit; make sure that the control unit linked to the «SECONDARY» ( <i>slave</i> ) circuit has been correctly set as «SECONDARY» on menu 105
FAULT SAFETY EDGE	Safety edge fault - Check the metal wire of the safety edge and the cables wirings. Check that the contact is closed by accessing the «INPUT STATUS» menu ( <i>paragraph 14.3</i> )
FAULT PHOTO 1 10K	10K photocell fault - Check the photocell wirings or any short-circuits. Check that the photocell is correctly powered. Make sure that a photocell with 10K protection has actually been connected



## 19.2 - FAULTS SIGNALLED ON THE FLASHING LIGHT

- It is also possible to visualize the warning signals through the flashing light simply by observing the number of flashes emitted (*see the table of correspondences below*)
- When an event occurs, the warning flashes will be issued at each «START» command

ALARM TYPE	NUMBER OF FLASHES
MOTOR FAILURE	9 SLOW (EVERY 0.5 SEC) FOR 10 TIMES
PHOTOCELL FAILURE DURING CLOSING	2 SLOW (EVERY 0.5 SEC) 5 TIMES
PHOTOCELL FAILURE DURING OPENING	3 SLOW (EVERY 0.5 SEC) FOR 1 TIME
COLLISION - OBSTACLE DETECTED DURING OPENING	6 SLOW (EVERY 0.5 SEC) 11 TIMES
COLLISION - OBSTACLE DETECTED DURING CLOSING	6 SLOW (EVERY 0.5 SEC) 11 TIMES
SAFETY EDGE FAILURE	4 SLOW (EVERY 0.5 SEC) 3 TIMES
«RT» POTENTIOMETER OR «POSITION GATE» FAULT	11 FAST (EVERY 0.2 SEC) 4 TIMES
FAULT ON STOP CONTACT	5 SLOW (EVERY 0.5 SEC) FOR 2 TIMES
LIMIT SWITCH FAILURE OR ERROR	4 FAST (EVERY 0.2 SEC) 11 TIMES
MAX. CYCLES ACHIEVED-MAINTENANCE REQUIRED	7 SLOW (EVERY 0.5 SEC) FOR 2 TIMES

➔ The «CYCLES ALARM» warning refers to the reaching of the maximum cycles number established after which the maintenance is necessary

## 19.3 - «DIAGNOSTICS» MENU TO DISPLAY LATEST EVENTS

The warnings and the alarms remain in the control unit memory, up to a max. of 10 events. To see the stored events, access the menu 106. Below is the table with the type of events saved in the diagnostics

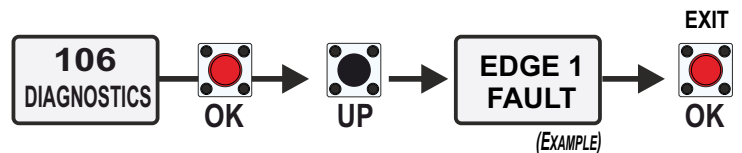

➔ If the fault message holds out, carry out the required checks or disconnect the device generating the fault

TYPE OF EVENT	WARNING MESSAGE STORED
EVENTS OR ALARMS REGARDING FAULTS ON MOTOR	MOTOR FAULT
EVENTS OR ALARMS REGARDING FAULTS ON PHOTOCELL 1 OR PHOTOCELL 2 IN OPENING	PHOTO OPENING
EVENTS OR ALARMS REGARDING FAULTS ON PHOTOCELL 1 OR PHOTOCELL 2 IN CLOSING	PHOTO CLOSING
EVENTS OR ALARMS REGARDING FAULTS ON 10K PHOTOCELLS	10K PHOTOCELL
EVENTS OR ALARMS REGARDING THE DETECTION OF OBSTACLES IN THE OPENING PHASE	OBSTACLE IN OPENING
EVENTS OR ALARMS CONCERNING THE DETECTION OF OBSTACLES IN THE CLOSING PHASE	OBSTACLE IN CLOSING
EVENTS OR ALARMS CONCERNING FAULTS ON THE SAFETY EDGE 1	SAFETY EDGE 1 FAULT
EVENTS OR ALARMS CONCERNING FAULTS ON THE SAFETY EDGE 2	SAFETY EDGE 2 FAULT
EVENTS OR ALARMS CONCERNING FAULTS ON THE ABSOLUTE POTENTIOMETER	POT.1 FAULT
EVENTS OR ALARMS CONCERNING FAULTS ON THE «STOP» CONTACT	STOP
REACHING OF THE MAXIMUM CYCLES ESTABLISHED - MAINTENANCE REQUIRED	MAINTENANCE
EVENTS OR ALARMS CONCERNING FAULTS ON THE MAIN POWER SUPPLY	MISSING NETWORK
EVENTS OR ALARMS CONCERNING FAULTS ON THE OPENING OR CLOSING LIMIT SWITCHES	LIMIT SWITCH
EVENTS OR ALARMS CONCERNING THE EMERGENCY MANŒUVRES PERFORMED	CLOSE ALWAYS
EVENTS OR ALARMS CONCERNING THE EMERGENCY MANŒUVRES PERFORMED	EMERGENCY



**IT IS ALWAYS RECOMMENDED TO CONSULT THE CHAPTER 20 DEDICATED TO TROUBLESHOOTING. MOST OF THE PROBLEMS CAN BE SOLVED BY FOLLOWING THE GIVEN INSTRUCTIONS!**

## 20 - TROUBLESHOOTING



**MAKE SURE THAT ALL THE SAFETY DEVICES ARE ENABLED**

PROBLEM	POSSIBLE REASON	SOLUTION
The operator does not respond to any START command	a) Check that the N.C. are connected b) Blown fuse	a) Check the connections and the jumpers on the safety edge or stop or photocell inputs, if connected b) Replace the blown fuse on the control unit
The operator does not run and the diagnostic display is off	a) The control unit is not powered b) Fuse open c) Defective control unit	a) Check the AC power supply b) Check the fuses c) Replace the defective control unit
The operator does not respond to a wired command (example: Opening, Closing, etc.)	a) Check the inputs of the opening and closing commands b) The STOP button is activated c) The Reset button is blocked d) Anti-entrapment safety device active	a) Check all the opening and closing inputs to make sure they are not blocked b) Check the STOP button is not blocked c) Check the Reset button d) Check among all the inputs of the anti-entrapment protection device, if there is a blocked sensor
The operator does not respond to a remote control	a) The STOP button is activated b) The Reset button is blocked c) Poor radio reception	a) Check the STOP button is not blocked b) Check the Reset button c) Check if the other wired devices are working correctly; check the antenna cable
The motor runs in one direction only	a) Check the resistance between the motor phase and neutral and verify that the resistance is MOhm b) Try to invert the motor phase and see if it changes direction or not	a) Replace the cable b) If the motor is blocked, replace the cable; if the motor moves in one direction only, the motor direction relay is damaged
The gate does not move but the motor runs	a) The engine is in the locked position b) Presence of an obstacle	a) Release the motor b) Remove the obstacle
The gate does not reach the complete open or closed position	a) Wrong limit switch setting b) Programming error c) Gate is stopped by an obstacle d) Torque too low e) The gate is too heavy to perform the automatic slowdown	a) Set the limit switches b) Repeat the working times programming c) Remove the obstacle d) Increase the torque parameter e) Set the slowdown to OFF
The gate opens but does not close	a) The photocells contacts are connected and open b) Stop contact connected and open c) The safety edge contact is open d) Amperometric alarm	a) b) c) Check the jumpers or the connected devices or the warning signals on the flashing lamp d) Check for a possible the amperometric alarm and, if necessary, increase the torque parameter
The gate does not close automatically	a) Pause time set too high b) Semi-automatic logic control unit	a) Adjust the pause time b) Set the PAUSE TIME menu to a value different than OFF
The gate moves, but the limit switches cannot be set correctly	a) The gate does not move towards a stop position b) It is too difficult to move the gate	a) Manually unlock and move the gate and make sure the gate moves easily from limit switch to limit switch. If necessary, repair the gate b) The gate must be able to move easily and freely throughout its travel, from limit switch to limit switch. If necessary, repair the gate
The gate does not fully open or close when the limit switches are set	a) The gate does not move towards a limit switch b) It is too difficult to move the gate	a) Manually unlock and move the gate and make sure the gate moves easily from limit switch to limit switch. If necessary, repair the gate b) The gate must be able to move easily and freely throughout its travel, from limit switch to limit switch. If necessary, repair the gate
The gate stops during travel and reverses direction	a) Open/Close control active b) The obstacle detection sensitivity is too low	a) Check if there is an active input among all the opening and closing inputs b) Check the obstacle detection sensitivity value and try to increase it
The gate opens but does not close with TX or closing timer	a) Opening control active b) Pause not set c) The closing anti-entrapment protection device is active d) The photocell contact is open e) The fire switch input is active	a) Check if there is an active input among the open inputs b) Check the pause settings c) Check if there is an active sensor among all the inputs of the anti-entrapment protection device d) Check the contact of the photocells e) Check the fire switch input

PROBLEM	POSSIBLE REASON	SOLUTION
The gate does not respect the slowdown start points	<ul style="list-style-type: none"> <li>a) The encoder does not work properly when activated</li> <li>b) Slow mechanical clutch</li> <li>c) Too large deceleration space</li> <li>d) The potentiometer does not work correctly when activated</li> <li>e) The parameters of the recovery position are too high or too low</li> </ul>	<ul style="list-style-type: none"> <li>a) Check in the Encoder menu that the "Encoder Par" parameter is set from a low value of +/- 10 (gate completely closed) to "Encoder tot" (gate completely open). If the IPAR movement is not in line with the range of values (from +/- 10 to "Encoder tot") probably the encoder is defective</li> <li>b) Tighten the mechanical clutch</li> <li>c) Reduce the slowdown space</li> <li>d) Check in the Potentiometer menu that the "IPAR" parameter is set from "I.CH." (gate completely closed) to "I.AP." (gate completely open). If the "IPAR" movement is not in line with the range of values (from I.AP. to I.CH.), the potentiometer is probably faulty</li> <li>e) Reduce or increase the values of the "recovery position"</li> </ul>
The gate opens suddenly but any START command have been given	<ul style="list-style-type: none"> <li>a) Frequency or disturbances on the main line</li> <li>b) Short-circuit on the START contact</li> </ul>	<ul style="list-style-type: none"> <li>a) The AC wiring must be separated from the DC wires and run through separate conduits. If it is a frequency disturbance, you can change the frequency to another MHz value, such as 868 or FM</li> <li>b) Check all the START contacts</li> </ul>
The gate does not accept the close command during the pause in automatic logic, even if the loop or photocell are set as Start	<ul style="list-style-type: none"> <li>a) START IN PAUSE is not ON</li> <li>b) The photocell/loop input is not set as "pause reload"</li> </ul>	<ul style="list-style-type: none"> <li>a) Turn ON the START IN PAUSE menu</li> <li>b) Set "pause reload" in the photocell / loop menu</li> </ul>
The gate does not have the necessary force to close or reach the limit switch	<ul style="list-style-type: none"> <li>a) Slowing down is not possible either because the gate is too heavy or because of the inclination or because the installation is not new</li> </ul>	<ul style="list-style-type: none"> <li>a) Set the slowdown to OFF</li> </ul>
The gate travel is obstructed and cannot stop or reverse	<ul style="list-style-type: none"> <li>a) Force the necessary adjustment</li> </ul>	<ul style="list-style-type: none"> <li>a) Refer to the adjustment parameter to carry out the obstruction tests and make the correct adjustments of the force (sensitivity - torque)</li> </ul>
The photocell does not stop or reverse the gate travel	<ul style="list-style-type: none"> <li>a) The photocell wiring is incorrect</li> <li>b) The photocell is faulty</li> <li>c) The photocells have been installed too far apart</li> </ul>	<ul style="list-style-type: none"> <li>a) Check the photocell wiring. Check that the gate stops and reverses its direction when the photocell is engaged</li> <li>b) Replace the faulty photocell. Check that the gate stops and reverses its direction when the photocell is engaged</li> <li>c) Install the photocells closer or use safety edges with sensors</li> </ul>
The safety edge does not stop or reverse the travel of the gate	<ul style="list-style-type: none"> <li>a) Incorrect wiring of the edge sensor</li> <li>b) Defective edge sensor</li> </ul>	<ul style="list-style-type: none"> <li>a) Check the safety edge wiring. Check that the gate stops and reverses its direction when the edge is activated</li> <li>b) Replace the defective safety edge and check that the gate stops and reverses its direction when it is activated</li> </ul>
The alarm sounds for 5 minutes or the alarm sounds after a command	<ul style="list-style-type: none"> <li>a) A double entrapment has occurred (two obstructions within a single activation)</li> </ul>	<ul style="list-style-type: none"> <li>a) Check the cause of the entrapment detection (obstruction) and correct it. Press the reset button to silence the alarm and reset the operator</li> </ul>
The shadow loop does not hold the gate on the opening limit switch	<ul style="list-style-type: none"> <li>a) Shadow loop sensor incorrectly adjusted</li> <li>b) Defective shadow loop sensor</li> <li>c) Wrong setting</li> </ul>	<ul style="list-style-type: none"> <li>a) Check the shadow loop settings and reset as needed</li> <li>b) Replace the defective vehicle sensor</li> <li>c) Check that menu 98 is on SHADOW LOOP</li> </ul>
The accessories connected to the accessory power supply do not work properly, they turn off or restart	<ul style="list-style-type: none"> <li>a) Accessory power supply protection active</li> <li>b) Defective electronic control unit</li> </ul>	<ul style="list-style-type: none"> <li>a) Disconnect all devices powered by the "accessories power supply" and measure their voltage (must be 23-30 Vdc). If the voltage is correct, reconnect the accessories one at a time, measuring each time the voltage</li> <li>b) Replace the defective control unit</li> </ul>
Fault on the 24VAUX	<ul style="list-style-type: none"> <li>a) Overload/short-circuit on AUX input</li> <li>b) Blown fuse</li> </ul>	<ul style="list-style-type: none"> <li>a) Check if the cable is shorted</li> <li>b) Replace the fuse</li> </ul>
The control unit turns on but the motor does not run	<ul style="list-style-type: none"> <li>a) STOP active or wrong jumpers</li> <li>b) Open or close the active input</li> <li>c) Active Entrapment Protection Device</li> <li>d) Defective electronic control unit</li> </ul>	<ul style="list-style-type: none"> <li>a) Check that the STOP button is not blocked, that it is a N.C. contact or put a jumper on the Stop input</li> <li>b) Check that none of the opening and closing inputs are blocked</li> <li>c) Check whether there is a blocked sensor among all the entrapment protection device inputs</li> <li>d) Replace the defective control unit</li> </ul>

# GATE 1 DG (R2BF) - (R2EF) - (R3BF) MENU FUNCTIONS TABLE

THE DESCRIBED FUNCTIONS ARE VALID FOR ALL GATE 1 DG VERSIONS, EXCEPT WHERE EXPRESSLY STATED

MENU		SET	DESCRIPTION	DEFAULT	NOTES
1	LANGUAGE	<i>Italiano</i>	Italian	English	
		<i>English</i>	English		
		<i>Français</i>	French		
		<i>Español</i>	Spanish		
		<i>Dutch</i>	Dutch		
		<i>Polski</i>	Polish		
2	TRANSMITTERS	<i>Start</i>	Start	Start  Partial Opening	
		<i>Partial opening</i>	Partial opening		
		<i>External module</i>	External module		
		<i>Stop</i>	Stop		
		<i>Bistable Stop</i>	Pressed once, it stops the gate. Pressed twice, it reactivates the START input		
		<i>Latch opening</i>	One impulse opens and keep open. A second impulse restore the movement		
		<i>Latch closing</i>	One impulse closes and keep closed. A second impulse restore the movement		
		<i>Unlock</i>	To store a command for unlocking the electric brake		
		<i>Delete a transmitter</i>	To delete a single transmitter (TX)		
		<i>Move to EEP</i> <b>Menu available on model R3BF only</b>	To transfer the transmitters stored on the control unit to the external EEPROM (MEM), if connected		
		<i>Clear memory</i>	To delete the full transmitters memory on the receiver		
		<i>End</i>	To exit the menu "transmitters"		
3	MOTOR	<b>1- Hydraulic</b>	Hydraulic operators	Mechanic	
		<b>2- Sliding</b>	Sliding operators		
		<b>3- Reversible Sliding</b>	Reversible sliding operators		
		<b>4- Mechanic Swing</b>	Electro-mechanic swing operators		
		<b>5- Three-phase and Bollards</b>	Three-phase operators Bollards		
		<b>6- Magnetic Sliding</b>	Sliding operators with magnetic limit-switch		
		<b>7- Barrier</b>	Barriers		
		<b>12- B-200</b>	Sliding operator		
		<b>13- Chain sliding operator</b>	Sliding chain operator Slowdown OFF - deceleration 70% - Buzzer in ON PHOTO 2 as shadow loop		
		<b>14- B-200 chain</b>	Sliding chain operator		
		<b>15- Erg</b>	Garage door operator		
		<b>50- Taurus Mag Fast Chain</b>	Sliding chain operator		
		<b>51- Taurus Rack Fast</b>	Sliding rack operator		
		<b>82- Absolute sliding (RT)</b>	Sliding operator with RT Absolute Encoder		

MENU		SET	DESCRIPTION	DEFAULT	NOTES	
5	REVERSE MOTOR	On	To reverse the opening with the closing and vice-versa <b>(both motors and limit-switches are reversed)</b>	Off		
		Off	Off			
6	LOGIC	Automatic	Automatic logic - <b>automatic reclosing enabled</b>	Auto- matic		
		Open-stop-close-stop-open	Step by step type 1			
		Open-stop-close-open	Step by step type 2			
		2 button	Two buttons			
		Safety	Safety			
		Dead man	Dead man			
7	TIMER TO CLOSE	Off	Semi-automatic logic enabled <b>(a START command opens and another START closes the gate - automatic reclosing disabled)</b>	Off		
		1            240	To set a pause time (from 1 second to 4 minutes) before the automatic reclosing			
8	START IN PAUSE	Off	The Start command is not accepted during pause	Off		
		On	The Start command is accepted during pause			
9	PROGRAMMING	Off            On	To start the working times learning	Off		
		Motor Direction	<b><u>This menu is shown only in case of sliding operators with "RT" Encoder</u></b> - it allows to program the operator in manual mode			
10	TEST START	Off            On	To give a Start command for testing the automation	Off		
13	LATCH PAUSE	Off            On	If "ON" the operator complies with the pause time set when the function "LATCH OPENING" is disabled. When "OFF" the pause time set is not respected	Off		
14	RESET	A count-down of 5 seconds will start by holding the UP button; at its end "INIT" will appear on the display as confirmation of the control board reset				
192	MOVE GATE 1 *	Allows the movement of the gate in a temporary "dead man" mode (for example to test the correct running of the motor) HOLD <b>UP</b> PRESSED = THE GATE OPENS HOLD <b>DOWN</b> PRESSED = THE GATE CLOSES			----	
* The command is accepted only at the end of the cycle or after a STOP command; it is not accepted during the cycle and during the pause						
15	END	Press OK to return to the display of the firmware version and to the one of inputs state				
16	SPECIAL MENU	Press OK to enter the special menu				





# SPECIAL MENU

PRESS AT THE SAME TIME FOR 5 SECONDS TO ENTER OR TO EXIT THE SPECIAL MENU

THE DESCRIBED FUNCTIONS ARE VALID FOR ALL GATE 1 DG VERSIONS, EXCEPT WHERE EXPRESSLY STATED

SPECIAL MENU		SET		DESCRIPTION	DEFAULT	NOTES
25	LEARNING SPEED	50%	100 %	To adjust the working times learning speed. <b>The menu is shown only if the 3-MOTOR menu is set to "50-TAURUS MAG" or to "82-Absolute Sliding"</b>	50	
28	OPENING TORQ 1	10	100	<b>Motor 1 opening torque:</b> by increasing the torque, more strength will be required to execute the inversion in case of obstacle. <b>with hydraulic motors the torque will be on 100%</b>	It depends on model	
29	CLOSING TORQ 1	10	100	<b>Motor 1 closing torque:</b> by increasing the torque, more strength will be required to execute the inversion in case of obstacle. <b>with hydraulic motors the torque will be on 100%</b>	It depends on model	
32	ENCODER	On		<b>ON</b> = Encoder enabled <b>OFF</b> = Encoder disabled <b>(when OFF, the working times learnt are only shown)</b>	Off	
47	ENCODER PAR. M1	xxx.		Impulses read by Encoder during operation ( <b>Motor 1</b> )		
48	ENCODER TOT. M1	xxx.		Impulses stored during programming ( <b>Motor 1</b> )		
32	ENCODER	Position Gate		To enable the reading of the potentiometer <b>(only if connected via LE or LSE management unit)</b>	Off	
		RT		To enable the reading of the Absolute Encoder <b>(only if connected via LRT management unit)</b>		
51	I.PAR. M1 *	-----		To show the current position of the potentiometer on the leaf moved by <b>Motor 1</b> . This parameter is useful to see if the potentiometer is correctly read		
52	I.AP. M1	From the value learned to ± 100 pulses		To show the impulses stored by the control unit when the leaf moved by <b>Motor 1</b> is fully open		
53	I.CH. M1	From the value learned to ± 100 pulses		To show the impulses stored by the control unit when the leaf moved by <b>Motor 1</b> is fully close		
* While the partial impulses are displayed, it is possible to OPEN (by pressing UP) or CLOSE (by pressing DOWN) the operator to verify the correct reading of the potentiometer - <u>Function available only on model R3BF</u>						
32	ENCODER	Off		<b>ON</b> = Encoder enabled <b>OFF</b> = Encoder disabled <b>(when OFF, the working times learnt are only shown)</b>	Off	
65	OPENING TIME M1	xxx.s		To display the learnt value during the working times self learning, in opening and closing ( <b>Motor 1</b> ). With UP or DOWN it is possible to increase or reduce the working times		
66	CLOSING TIME M1	xxx.s				
33	OPENING SENSITIVITY MOTOR 1	10% (Fast intervention) 99% (Slow intervention)		To adjust the Encoder or Potentiometer intervention time on Motor 1 in opening	Off	
		Off (Intervention excluded)		Disabled - <b>Mandatory setting for version R2EF</b>		
34	CLOSING SENSITIVITY MOTOR 1	10% (Fast intervention) 99% (Slow intervention)		To adjust the Encoder or Potentiometer intervention time on Motor 1 in closing	Off	
		Off (Intervention excluded)		Disabled - <b>Mandatory setting for version R2EF</b>		

SPECIAL MENU		SET		DESCRIPTION	DEFAULT	NOTES
37	SLOWDOWN SENSITIVITY <b>Mandatory setting to OFF for version R2EF</b>	10% (Fast intervention) 99% (Slow intervention)		To adjust the amperometric sensitivity in slowdown <b>Function available only on electro-mechanic operators</b>	Off	
		Off (Intervention excluded)		Disabled - <b><u>Mandatory setting for version R2EF</u></b>		
		With potentiometer		To set the inversion time in slow-down from 0 to 5 seconds (= 99%) - <b>available only if the potentiometer or the RT absolute encoder have been wired and enabled</b>	It depends on model	
38	POTENTIOMETER THRESHOLD OPENING 1	1	1000 <b>(available only if the "Position Gate" or the "RT" Encoder have been wired)</b>	<b>To adjust the threshold of the Potentiometer or "RT" Encoder intervention.</b> This parameter self-determines during the working times learning but can also be adjusted later, on the condition that the set value is higher than the value shown in VP1 or VP2 (instantaneous speed values which can be shown by accessing the DEBUG menu). <b>NOTE: The lower the threshold value, the slower will be the response of the potentiometer</b>	It depends on model	
39	POTENTIOMETER THRESHOLD CLOSING 1					
42	POTENTIOMETER SLOWDOWN THRESHOLD OPENING 1	1	100 <b>(available only if the "Position Gate" or the "RT" Encoder have been wired)</b>	<b>To adjust the threshold of the Potentiometer or "RT" Encoder intervention in slowdown.</b> The value can be manually increased on the condition that the set value is higher than the value shown in VP1 (instantaneous speed values which can be shown by accessing the DEBUG menu)	It depends on model	
43	POTENTIOMETER SLOWDOWN THRESHOLD CLOSING 1					
46	CLOSING INVERSION	Total		In case of obstacle or safety edge it totally reverses the movement during closing. If the automatic reclosing is enabled ( <b>automatic logic</b> ), it is attempted for 5 times	It depends on model	
		Partial		In case of obstacle, safety edge or potentiometer, it partially reverses direction ( <b>of about 30 cm</b> ) then stops		
<b>The menus 47 - 48 are shown only if the menu 32- ENCODER = ON</b>						
<b>The menus 51 - 52 - 53 are shown only if the menu 32- ENCODER = Position Gate or RT</b>						
59	OPENING SLOWDOWN 1	Off (*)	50	Adjustable from OFF to the 50% of the stroke	It depends on model	
60	CLOSING SLOWDOWN 1	Off (*)	50	Adjustable from OFF to the 50% of the stroke	It depends on model	
<b>Sliding operators equipped with «RT» Absolute Encoder can be set from 5% to 50%</b>						
<b>* For motors with hydraulic brake (CF) or double hydraulic brake (2CF) this parameter must be on Off</b>						
63	DECELERATION	0 %		To adjust the change from normal speed to slowdown speed	It depends on model	
64	ACCELERATION	0 %		Acceleration ramp. To adjust the motor start	It depends on model	
<b>The menus 65 - 66 are shown only if the menu 32- ENCODER = OFF</b>						
70	OPENING POSITION RECOVERY	0	20 seconds	To retrieve the inertia of the motor in opening after the Stop or the reversing	1s	
71	CLOSING POSITION RECOVERY	0	20 seconds	To retrieve the inertia of the motor in closing after the Stop or the reversing	1s	
72	OPENING TOLERANCE MOTOR 1	0	100	To adjust the Motor 1 tolerance between the stop and the obstacle, in opening	0	
73	CLOSING TOLERANCE MOTOR 1	0	100	To adjust the Motor 1 tolerance between the stop and the obstacle, in closing	0	

SPECIAL MENU		SET		DESCRIPTION	DEFAULT	NOTES
76	PUSHING STROKE	<i>Time Pushing Stroke</i>	<i>Off - 3 sec</i>	Before opening, the motor starts in closing for the time set, in order to simplify the lock release	Off	
		<i>Repeat Lock Release</i>	<i>Off - On</i>	If <b>ON</b> , the lock will be released both before and after the pushing stroke		
		<i>End</i>		To exit the menu		
79	ANTI INTRUSION	<i>Only opening</i>		If the gate moves, whether due to wind or manual forcing, the function starts up the operator to restore the initial position. <b>(function available only if limit switch or potentiometer or encoder "RT" are installed)</b>	Off	
		<i>Only closing</i>				
		<i>Opening and closing</i>				
		<i>Off</i>				
80	PUSHOVER	<i>Off</i>		The gate leaf makes an extra movement at the maximum torque to ensure the tightening of the gate <b>In case of a STOP command, the Pushover function is restored only after a new START command</b>	Off	
		<i>Opening and closing</i>				
		<i>Only closing</i>				
		<i>Only opening</i>				
81	PERIODIC PUSHOVER	<i>Off</i>	<i>8h</i>	To activate the repetition of the pushover function at a distance of time adjustable from 0 to 8 hours, at hourly intervals	Off	
82	MOTOR RELEASE	<i>Opening 1</i>	<i>Off - 3 s</i>	If different from OFF, the operator slightly reverses its direction at the end of the cycle	Off <i>(hydraulic)</i> 0.1 <i>(mechanic)</i>	
		<i>Closing 1</i>	<i>Off - 3 s</i>			
		<i>Opening 2</i>	<i>Off - 3 s</i>			
		<i>Closing 2</i>	<i>Off - 3 s</i>			
		<i>End</i>				
83	EXTRA TIME	<i>0.0 s</i>	<i>10 s</i>	If the limit switches are installed, it is possible to add an extra time (max. 10 seconds) to the movement of the operator after the reading of the limit switches <b>Note: If an Encoder is installed, the space can be set by impulses (from 0 to 100)</b>	0.0 s	
84	BRAKE	<i>Off</i>	<i>100%</i>	To adjust the braking on the limit switch	0	
85	PRE-FLASHING	<i>Only closing</i>		To enable the pre-flashing only before closing <b>(to access: press DOWN button when 0.0 value is shown)</b>	Off	
		<i>0.0</i>	<i>10 s</i>	To set the pre-flashing duration		
86	FLASHING LIGHT	<i>Normal</i>		Normal	Normal	
		<i>Light</i>		Warning lamp function		
		<i>Always</i>		Always ON		
		<i>Buzzer</i>		Buzzer		
87	FLASHING LIGHT AND TIMER	<i>Off</i>		The flashing light will be OFF with enabled timer and open gate	Off	
		<i>On</i>		The flashing light will be ON with enabled timer and open gate		
88	COURTESY LIGHT	<i>Off</i>		Disabled	20	
		<i>1</i>	<i>240</i>	Adjustable from 1 second to 4 minutes		
		<i>In cycle</i>		Courtesy light only in cycle		
89	TRAFFIC LIGHT RESERVATION	<i>Off</i>	<i>On</i>	To get the priority in entry (via a START command) or in exit (via a PARTIAL START command). <b>The function is available only with a traffic light wired via SEM management unit</b>	Off	
90	PARTIAL OPENING	<i>20</i>	<i>100</i>	Adjustable from 20 to 100	100	



SPECIAL MENU		SET	DESCRIPTION	DEFAULT	NOTES
91	PARTIAL PAUSE	= Start	The pause in partial opening is the same as in total opening	= Start	
		Off	Disabled		
		1            240	Adjustable from 1 second to 4 minutes		
92	TIMER	Off	The selected input will be turned into an input (on CN1) to which connect an external clock	Off	
		On Photocell 2			
		On Partial Start			
93	FIRE SWITCH	Off	Disabled	Off	
		On Photocell 2	The function can be enabled on the Photocell 2 input		
		On Partial Start	The function can be enabled on the Partial Start input		
94	24V AUX (Max. 500 mA) The AUX output allows the connection of a relay for the additional accessories management	Always	AUX output always powered	Always	
		In cycle	AUX output powered only during cycle		
		Opening	AUX output powered only during opening		
		Closing	AUX output powered only during closing		
		In pause	AUX output powered only during pause		
		Phototest	AUX output powered for safety devices testing		
		In cycle and phototest	AUX output powered only during cycle and for safety devices testing		
		Positive brake management (connected through relay)	Positive Electric-brake - <b>connected through relay (AUX output powered only with stationary gate)</b>		
		Negative brake management (connected through relay)	Negative Electric-brake - <b>connected through relay (AUX output powered during cycle and 1 second before starting the movement)</b>		
		Negative brake management (connected through relay) Photocell management	Negative Electric-brake <b>(AUX output powered during cycle and 1 second before starting the movement; AUX output disabled when the photocell is activated)</b>		
		Open gate warning light	<b>1 flash per second</b> during opening <b>2 flashes per second</b> during closing <b>Steady lit</b> in "Stop" or "Open" status		
		Lock (connected through relay)	The AUX output allows the connection of a relay for the management of a lock <b>Note: to connect the lock, a relay and an external power supply are necessary</b>		
		Opening and open	AUX output powered during opening and with open gate		
		Courtesy light (connected through relay)	The AUX output allows the connection of a relay for the management of a courtesy light which will work as per Menu-88 settings		
Start 3 s (connected through relay)	AUX output powered at every Start input or at every photocells or safety edge intervention, for 3 seconds <b>(ie. management of lights connected through the relay)</b>				
Barrier Led lights	<b>Closed barrier</b> - the light is switched-on <b>Open barrier</b> - the light is switched-off <b>Moving barrier</b> - the light blinks				

SPECIAL MENU		SET	DESCRIPTION	DEFAULT	NOTES
95	PHOTO-TEST	<i>Photocell 1</i>	Self-test enabled only on photocell 1	<i>Off</i>	
		<i>Photocell 2</i>	Self-test enabled only on photocell 2		
		<i>Photocells 1 and 2</i>	Self-test enabled on photocells 1 and 2		
		<i>Off</i>	Disabled		
		<i>Safety Edge 1</i>	Self-test enabled only on safety edge		
		<i>Photocell 1 Safety Edge</i>	Self-test enabled on photocell 1 and safety edge		
		<i>Photocell 2 Safety Edge</i>	Self-test enabled on photocell 2 and safety edge		
		<i>All</i>	Self-test enabled on photocell 1 and 2 and safety edge		
97	PHOTOCELL 1 SHADOW LOOP 1	<i>Closing</i>	If the photocell is occupied during closing, the gate reverses the movement; If the photocell is occupied during the pause, it prevents the gate reclosing	<i>Closing</i>	
		<i>Opening and closing</i>	If the photocell is occupied during opening or closing, it stops the gate movement; when the photocell is released, the movement continues		
		<i>Stop</i>	If the photocell is occupied before the Start input, the Start will be ignored. If the photocell is occupied after the Start input, the photocell will be ignored. If the photocell is occupied during closing, the gate will reopen		
		<i>Stop and close</i>	If the photocell is occupied during closing, it stops the gate movement; when released, the closing movement continues		
		<i>Close</i>	The photocell stops the gate until it is occupied in both opening and closing; when released, it send a closing input <b>(the gate closes 1s after the photocell release)</b>		
		<i>Pause reload</i>	If the photocell is occupied during opening or closing, it stops the gate movement; when released, the movement continues. If the photocell is occupied during the pause, it recharges the pause time set		
		<i>Shadow loop</i>	When the gate is open, the shadow loop prevents the reclosing until it is occupied. The Shadow loop is switched off during closing		
		<i>Delete pause time</i>	If the photocell is occupied during opening, pause or closing, the gate reopens completely and closes without observing the pause time set		
		<i>Shadow loop RP (pause reloading)</i>	When the gate is open, the shadow loop prevents the reclosing until it is occupied. When released, the gate repeats the pause time set, then it closes. The Shadow loop is switched off during closing		

SPECIAL MENU		SET	DESCRIPTION	DEFAULT	NOTES
98	PHOTOCELL 2 SHADOW-LOOP2	<i>Closing</i>	If the photocell is occupied during closing, the gate reverses the movement; If the photocell is occupied during the pause, it prevents the gate reclosing		
		<i>Opening and closing</i>	If the photocell is occupied during opening or closing, it stops the gate movement; when the photocell is released, the movement continues		
		<i>Stop</i>	If the photocell is occupied before the Start input, the Start will be ignored. If the photocell is occupied after the Start input, the photocell will be ignored. If the photocell is occupied during closing, the gate will reopen		
		<i>Stop and close</i>	If the photocell is occupied during closing, it stops the gate movement; when released, the closing movement continues		
		<i>Close</i>	The photocell stops the gate until it is occupied in both opening and closing; when released, it send a closing input <b>(the gate closes 1s after the photocell release)</b>		
		<i>Pause reload</i>	If the photocell is occupied during opening or closing, it stops the gate movement; when released, the movement continues. If the photocell is occupied during the pause, it reloads the pause time set		
		<i>Pause reload Photo closing</i>	If the photocell is occupied during the pause, it reloads the pause time set. If the photocell is occupied during closing, the gate reverses the movement		Opening and Closing
		<i>Shadow loop</i>	When the gate is open, the shadow loop prevents the reclosing until it is occupied. The Shadow loop is switched off during closing		
		<i>Delete pause time</i>	If the photocell is occupied during opening, pause or closing, the gate reopens completely and closes without observing the pause time set		
		<i>Shadow loop RP (pause reloading)</i>	When the gate is open, the shadow loop prevents the reclosing until it is occupied. When released, the gate repeats the pause time set, then it closes. The Shadow loop is switched off during closing		
		<i>Stop and open</i>	If the photocell is occupied during opening, the gate will stop; when released, the gate continues the opening movement. The photocell is ignored during closing		
		<i>Stop N.O.</i>	Stop connection on ERG push-button panel		
		<i>Safety edge 2</i>	To enable the second safety edge <b>With models "R2BF" and "R2EF"</b> only the connection of a Standard Safety Edge ( <i>Normal</i> ) is allowed <b>With model "R3BF"</b> the connection of different Safety Edge types is allowed; Select the type on menu 101; <b>With all models</b> it is possible to choose the working direction of the second safety edge by the menu 103		

SPECIAL MENU		SET		DESCRIPTION	DEFAULT	NOTES
100	SAFETY EDGE 1 <b>Menu available on models R2BF and R2EF only</b>	Normal		Standard safety edge - N.C. contact	Normal	
		8K2		Safety edge protected by a 8K2 resistor enabled		
		8K2 Double		Two safety edges protected by a 8K2 resistor enabled		
		Photo 1 10K		Photocell protected by a 10K resistor enabled		
		Photo 1 10K Double		Two photocells protected by a 10K resistor enabled		
	SAFETY EDGE 1 <b>Menu available on model R3BF only</b>	Normal		Standard safety edge - N.C. contact		
		8K2 N.C.		Safety edge protected by a 8K2 resistor enabled		
		8K2 N.C. Double		Two safety edges protected by 8K2 resistor enabled		
		8K2 RES		Resistive edge protected by 8K2 resistor enabled		
		8K2 RES Double		Two resistive edges protected by 8K2 RES enabled		
101	SAFETY EDGE 2 <b>Menu available on model R3BF only and if the menu 98 is set on "SAFETY EDGE 2"</b>	Normal		Standard safety edge - N.C. contact	Normal	
		8K2 N.C.		Safety edge protected by a 8K2 resistor enabled		
		8K2 N.C. Double		Two safety edges protected by 8K2 resistor enabled		
		8K2 RES		Resistive edge protected by 8K2 resistor enabled		
		8K2 RES Double		Two resistive edges protected by 8K2 RES enabled		
102	SAFETY EDGE 1 DIRECTION	Opening and closing		Safety edge enabled in opening and closing	Opening and Closing	
		Only opening		Safety edge enabled only in opening		
		Only closing		Safety edge enabled only in closing		
103	SAFETY EDGE 2 DIRECTION <b>Menu available only if the menu 98 is set on "SAFETY EDGE 2"</b>	Opening and closing		Safety edge enabled in opening and closing	Opening and Closing	
		Only opening		Safety edge enabled only in opening		
		Only closing		Safety edge enabled only in closing		
104	SELECT LIMIT SWITCH	Automatic		Automatic detection of the limit switch	Automatic	
		Only opening		Limit switch enabled only in opening		
		Only closing		Limit switch enabled only in closing		
		Motor internal		To be enabled if the operator is equipped with an inner limit switch that stops the motor phase		
105	PRIMARY/SECONDARY (MASTER/SLAVE)	Primary		To set the control unit as <b>PRIMARY</b> on applications with two operators in primary/secondary mode		
		Secondary		To set the control unit as <b>SECONDARY</b> on applications with two operators in primary/secondary mode		
		Off		Disabled		
106	DIAGNOSTICS	1	10	To display the last event ( <b>See alarms table</b> )		
107	MAINTENANCE CYCLES	100	240000	Adjustable from 100 to 240000 cycles	100000	
108	PERFORMED CYCLES	0	240000	To display the executed cycles. <b>Hold pressed OK to reset the cycles</b>	0	
109	THERMOMETER	On	Off	To enable the probe for measuring the piston oil temperature; <b>The temperature probe must be connected via the LE or LSE management circuit</b>	Off	

SPECIAL MENU		SET	DESCRIPTION	DEFAULT	NOTES
110	LOWER TEMPERATURE THRESHOLD	From -20° to +50°	To adjust the temperature threshold to enable the oil heater ( <b><i>This menu is shown only if the menu 109-Thermometer is set to ON</i></b> )	-10°	
111	UPPER TEMPERATURE THRESHOLD	From -20° to +50°	To adjust the temperature threshold to disable the oil heater ( <b><i>This menu is shown only if the menu 109-Thermometer is set to ON</i></b> )	0°	
112	PASSWORD	<b>Note: "0000" setting is not allowed</b>	To enter a password for blocking the control unit parameters modification	----	
113	EMERGENCY	Off	Disabled	Off	
		Last opening	In case of power failure, as soon as the battery charge drops below 22V, the gate opens one last time and remains open until the power is restored		
		Last closing	In case of power failure, as soon as the battery charge drops below 22V, the gate closes one last time and remains closed until the power is restored		
117	ALWAYS CLOSE	Off      240 seconds	In case of power failure, if the gate has been manually open, it closes only after the set time has elapsed ( <b><i>from 0 to 240 sec.</i></b> ) as soon as the power is restored	Off	
118	LATCH	Off	Disabled	Off	
		Opening	The gate opens and stay open till a new LATCH button input. <b><i>The latch function uses the "Partial Opening" N.O. input</i></b>		
		Closing	The gate closes and stay closed till a new LATCH button input. <b><i>The latch function uses the "Partial Opening" N.O. input</i></b>		
119	DISPLAY WRITING SPEED	From 30% to 100%	See Note 2 at the end of the table	80%	
120	BASIC MENU	Press OK to exit the special menu. The special menu switches off automatically after 20 minutes			
121	PHOTO 1 TYPE <b><i>Menu available on model R3BF only</i></b>	Normal	Standard photocell without 10K control	Normal	
		Photo 1 10K	Photocell with 10K control		
		Photo 1 10K DOUBLE	Double photocell with 10K control		
122	PHOTO 2 TYPE <b><i>Menu available on model R3BF only</i></b>	Normal	Standard photocell without 10K control	Normal	
		Photo 2 10K	Photocell with 10K control		
		Photo 2 10K DOUBLE	Double photocell with 10K control		
189	HOMING <b><i>This menu is not available if the menu 3 is set to 50 or 82</i></b>	Normal	In case of a power failure or in case of obstacle, the operator restarts at the normal speed	Normal	
		Deceleration	In case of a power failure or in case of obstacle, the operator restarts at a lower speed than the normal		
190	BASIC MENU <b><i>On model R3BF only</i></b>	Press OK to exit the special menu. The special menu switches off automatically after 20 minutes			
<p><b>Note 1:</b> after initialization, the parameters set on <b>menu 3 - MOTOR</b> and <b>104 - SELECT LIMIT SWITCH</b> always remain set to the value chosen during the programming operation</p> <p><b>Note 2:</b> if the <b>menu 119 - DISPLAY WRITING SPEED</b> is set to the minimum value of 30%, the display writing speed will be low. On the contrary, if it is set to the maximum value of 100%, the writing speed will be very high</p> <p><b>Please note:</b> the writing speed will not change on the <b>JOLLY 3 programmer</b></p>					

## PART FOR BOTH INSTALLER AND END-USER

**MAINTENANCE:** periodically, it would be advisable to reprogram the working times on the control unit according to the number of cycles performed over time and according to the type of operator, especially if changes in friction, malfunctions or non-compliance with the previously set working times are noticed. Periodically clean the optical system of the photocells.

**SAFETY PRECAUTIONS:** all electrical works and the choice of the operating logic should comply with the current regulations. A 16A/0,030 differential switch must be used. Separate the source cables (*operators, power supply*) and command cables (*photocells, push-buttons, etc*). Be sure the system is properly grounded. Always run cables in separate sheaths to prevent interferences

**SPARE PARTS:** send request for spare parts to: **SEA S.p.A. - Teramo - ITALY - [www.seateam.com](http://www.seateam.com)**

**SAFETY AND ENVIRONMENTAL COMPATIBILITY:** do not waste product packaging materials and/or circuits; do not dispose of the product with other domestic waste at the end of its life cycle. In order to avoid any possible environmental or health damage caused by irregular waste disposal, we recommend to separate this product from other types of waste and to recycle it in a responsible way in order to provide the sustainable re-use of material resources. Domestic users are invited to contact the retailer where the product has been purchased or the local office to get all the information related to differential waste collection and recycling of this kind of product.

**STORAGE:** T = -30°C/+60°C ; Humidity = min. 5% / max. 90% (without condensation); Materials must be properly packaged, handled with care and with appropriate vehicles

**WARRANTY LIMITS:** - see the sales conditions

**MAINTENANCE AND DECOMMISSION:** must be carried out only by specialized and authorized personnel

**THE MANUFACTURER CAN NOT BE DEEMED RESPONSIBLE FOR ANY DAMAGE OR INJURY CAUSED BY IMPROPER USE OF THIS PRODUCT**

*SEA S.p.A. reserves the right to make any required modification or change to the products and/or to this manual without any advanced notice obligation.*

### GENERAL NOTICE

1. Read carefully these instructions before beginning to install the product. Store these instructions for future reference
2. Don't waste product packaging materials and /or circuits
3. This product was designed and built strictly for the use indicated in this documentation. Any other use, not expressly indicated here, could compromise the good condition/operation of the product and/or be a source of danger. SEA S.p.A. declines all liability caused by improper use or different use in respect to the intended one.
4. The mechanical parts must comply with Directives: Machine Regulation 2006/42/CE and following adjustments, Low Tension (2006/95/CE), Electromagnetic Consistency (2004/108/CE); Installation must respect Directives: EN12453 and EN12445.
5. Do not install the equipment in an explosive atmosphere.
6. SEA S.p.A. is not responsible for failure to observe Good Techniques in the construction of the locking elements to motorize or for any deformation that may occur during use
7. Before attempting any job on the system, cut out electrical power and disconnect the batteries. Be sure that the grounding system is perfectly constructed, and connect to it the metal parts of the gate
8. Use of the indicator-light is recommended for every system, as well as a warning sign well-fixed to the frame structure.
9. SEA S.p.A. declines all liability concerning the automated system safety and efficiency, if components used are not produced by SEA
10. For maintenance, strictly use original parts by SEA.
11. Do not modify in any way the components of the automated system.
12. The installer shall supply all information concerning the system manual functioning in case of emergency and shall hand over to the user the warnings handbook supplied with the product.
13. Do not allow children or adults to stay near the product while it is operating. The application cannot be used by children, by people with reduced physical, mental or sensorial capacity or by people without experience or necessary training. Keep remote controls or other pulse generators away from children, to prevent involuntary activation of the system.
14. Transit through the leaves is allowed only when the gate is fully open.
15. The User must not attempt to repair or to take direct action on the system and must solely contact qualified SEA personnel or SEA service centers. The User can apply only the manual function of emergency.
16. The power cables maximum length between the central engine and motors should not be greater than 10 m. Use cables with 2,5 mm<sup>2</sup> section. Use double insulation cable (cable sheath) to the immediate vicinity of the terminals, in particular for the 230V cable. Keep an adequate distance (at least 2.5 mm in air), between the conductors in low voltage (230V) and the conductors in safety low voltage (SELV) or use an appropriate sheath that provides extra insulation having a thickness of 1 mm

# DECLARATION OF CONFORMITY

## DICHIARAZIONE DI CONFORMITÀ

SEA S.p.A. declares under its proper responsibility and, if applicable, under the responsibility of its authorised representative that, by installing the appropriate safety equipment and noise filtering, the products:

*La SEA S.p.A. dichiara sotto la propria responsabilità e, se applicabile, del suo rappresentante autorizzato che, con l'installazione degli adeguati dispositivi di sicurezza e di filtraggio disturbi, i prodotti:*

DESCRIPTION - DESCRIZIONE	MODEL - MODELLO	TRADEMARK - MARCA
GATE 1 DG R2BF (AND ALL ITS BY-PRODUCTS - E TUTTI I SUOI DERIVATI)	23001158	SEA

- are built to be integrated into a machine or to be assembled with other machinery to create a machine under the provisions of Directive 2006/42/CE;
- comply with the essential safety requirements related to the products within the field of applicability of the Community Directives 2014/35/UE and 2014/30/UE
- sono costruiti per essere incorporati in una macchina o per essere assemblati con altri macchinari per costruire una macchina ai sensi della Direttiva 2006/42/CE;
- sono conformi ai requisiti essenziali di sicurezza relativi ai prodotti entro il campo di applicabilità delle Direttive Comunitarie 2014/35/UE e 2014/30/UE

PLACE AND DATE OF ISSUE  
LUOGO E DATA DI EMISSIONE

TERAMO, 06/09/2022

THE MANUFACTURER OR THE AUTHORIZED REPRESENTATIVE  
IL COSTRUTTORE o IL RAPPRESENTATE AUTORIZZATO

SEA S.P.A.  
ZONA INDUSTRIALE SANT'ATTO  
64100 - TERAMO - ITALY  
+ 39 0 861 588341  
[www.seateam.com](http://www.seateam.com)

L'Amministratore  
The Administrator  
Ennio Di Saverio  



**Automatic Gate Openers**

International registered trademark n. 804888

**SEA S.p.A.**

**Zona Industriale Sant'Atto - 64100 - Teramo - ITALY**

**Tel. +39 0 861 588341 r.a.**

**[www.seateam.com](http://www.seateam.com)**